

Instruction Manual



Vibration Monitor M14

valid from version 00x.011

ROGA Instruments Im Hasenacker 56

56412 Nentershausen

Tel. +49 (0) 6485 - 88 15 803 Fax +49 (0) 6485 - 88 18 373

Email: info@roga-instruments.com Internet: <https://roga-instruments.com>

Contents

1. An Introduction to Controls and Indicators	1
2. Purpose	2
Measuring quantities	2
Interfaces	2
Outputs	2
Indicators	2
3. Function	3
Sensor Input	3
Transducer Sensitivity	3
Amplifier	3
Filter	3
Integrators	3
RMS Rectification	3
Peak Rectification	3
Frequency-Analysis (FFT)	3
Alarm Relay	3
Level Indicator	4
AC-Output	4
Overload Indicator	4
Sensor range	4
Power Supply	4
Interfaces	4
4. Installation	5
4.1 Selecting the Measuring Points	5
Sensor Attachment	5
DIN/ISO 20816-1	6
4.2 Attachment	7
DIN-Rail	8
Bus Connectors	8
4.3 Connection	9
Terminals	9
Supply Voltage	9
Sensor Input	9
Relay Outputs	10
Current Loop	10
AC Signal Output	11
5. Indicators	12
Overload	12
Bar Indicator	12
IEPE-LED	12
Optional Current Loop Display	12
6. Settings	15
6.1 General	15
6.2 Program for Setup and Measurement	15
6.2.1 Installation	15
Instrument Driver	15
PC Software Installation	16

6.2.2 Settings Menu	16
USB connection.....	17
RS-485 connection	17
Instrument Data	17
Saving and Loading Settings	17
Standard Settings.....	17
6.2.3 Sensor Settings	18
IEPE Supply	18
Sensitivity.....	18
6.2.4 Gain	18
6.2.5 Filter and Integration	18
6.2.6 Settings for Relay Outputs	19
Alarm Limit.....	19
Warn Limit	19
Switching Mode	19
Delays.....	19
Low-Latency Monitoring of Instantaneous Values	20
Relay at Overload and Sensor Error	21
6.2.7 4-20 mA Current Loop	21
Current Loop for FFT.....	21
6.2.8 Monitoring Modes	22
7. Measuring Functions	22
7.1 Measuring RMS and Peak Values.....	22
Measuring RMS and Peak Values	23
Plotter	23
Data Export	23
7.2 Frequency Analysis.....	24
Frequency Analysis	24
Data Export	25
8. Teach-in-Function for Alarm Limits	25
RMS-/Peak-Teach-in.....	25
FFT-Teach-in	25
9. Interfaces and Protocols.....	26
9.1 Overview.....	26
9.2 USB Communication in CDC Mode.....	26
Commands Format	26
Instruments Name	26
Date of Calibration	26
Set Calibration Values.....	26
Measuring Mode	26
Filter and Integrator.....	27
Gain	27
Read FFT.....	27
Factory Reset.....	27
Teach-in Factor	27
Alarm Threshold	28
Read RMS and Peak Values.....	28
Read Main Frequency and Amplitude.....	28
FFT Limit Values.....	29
RS-485 Baud rate	29

Relay Settings.....	29
Sensor Sensitivity	30
IEPE Supply	30
Warning Limit	30
Read Settings.....	30
MODBUS Address (RS-485).....	31
Detection	31
9.3 RS-485 Communication in ASCII Mode	31
9.4 MODBUS RTU	33
10. Calibration.....	38
Re-Calibration	38
Vibration Calibrator	38
11. Firmware Update	38
12. Measuring Machine Vibration.....	39
12.1 Measuring Vibration Severity or Unbalance Vibration.....	39
DIN/ISO 20816-1	39
12.2 Monitoring Roller Bearings	40
Crest Factor	40
Diagnosis Index to Sturm	41
13. Technical Data.....	42

Enclosures:Warranty

CE Declaration of Conformity

1. An Introduction to Controls and Indicators

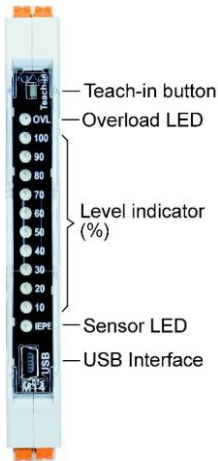

Figure 1: Front view

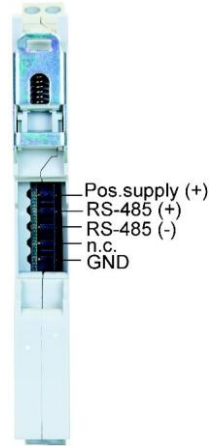

Figure 2: Back view

Back:	GND	GND	4-20 mA (+)
Front:	Sensor input	Pos. supply (+)	4-20 mA (-)



Back:	Relay output 1	Relay output 2	GND
Front:	Relay output 1	Relay output 2	AC output

Figure 3: Connectors

2. Purpose

The M14 is suitable for versatile tasks in the field of vibration measurement and monitoring. Typical applications include monitoring the smooth running of rotating machines to DIN/ISO 20816 and monitoring rolling bearings. The M14 enables maintenance technicians to recognize the early signs of wear and prevent consequential damages. In this way costs can be minimized and production breakdowns avoided. The instrument is also intended for process controlling and quality management. Due to its flexible settings the instrument can be optimized to suit application. The M14 provides standardized measuring values for subsequent processing.

Measuring quantities The M14 is designed for operation with IEPE compatible piezoelectric accelerometers. It can measure and monitor the following vibration quantities:

- vibration acceleration (without integration)
- vibration velocity (with single integration)

Numerous digital high and low pass filter combinations are available.

Besides monitoring in the time spectrum the M14 can measure the frequency spectrum of vibration acceleration, and monitor frequency selective. This enables selective monitoring from a mixture of vibration frequencies or several frequencies at once.

Interfaces The instrument has a USB-interface at the front and an RS-485 interface at the back. These allow software supported parameter setup and monitoring with a PC or PLC.

Outputs The vibration signal is channeled to the following outputs:

- AC-broadband output of the amplified, unfiltered sensor signal
- 4-20 mA current loop output for RMS or peak value of the selected vibration quantity

In addition to these it has two relay contacts for warning and alarm, with which you can activate shut-down or alarm devices.

Indicators The M14 has the following front indicators:

- LED level indicator, ten-step, two-tone
- Sensor control LED
- Overload LED

3. Function

Sensor Input The M14 works with piezoelectric sensors, which contain an integrated impedance converter to IEPE standards. Factory calibration of the M14 is carried out for typical industrial sensors with a sensitivity of 100 mV/g. We recommend the industrial accelerometers KS80D and KS81B from our product range with 100 mV/g sensitivity, an isolated base and protection grade IP67.

The constant current which powers the sensor electronics is provided by the M14 and can be switched off via the interfaces if required. This can be useful, for example, when two M14 are run with one sensor. In this case, the sensor should only be supplied by one of the two instruments.

Transducer Sensitivity Sensors with sensitivities between 0.8 and 12 mV/ms⁻² may be connected. The sensitivity settings are controlled via the interfaces.

Amplifier The sensor input is followed by an amplifier stage with gains of 1, 10 or 100. The instrument works with fixed gain or automatic gain adjustment (auto-ranging).

Filter The M14 offers numerous high pass and low pass filter combinations for the frequency range of 0.3 Hz to 10 kHz. These digital filters are of 2nd order IIR type.

Integrators When measuring vibration acceleration the sensor signal is processed without integrators. Vibration velocity, however, is measured with digital integration.

RMS Rectification The M14 measures true RMS, which ensures precise RMS rectification, even in the case of non-sinusoidal signals.

Peak Rectification As an alternative to RMS, the M14 can also form the peak value. RMS and peak can both be measured as a current loop signal (4.. 20 mA) via a terminal for external further processing or carried digitally via both interfaces to other instruments. The output rate is ca. 1 value / second. With peak measurement the maximum value since the last output is retained. After every output peak value measurement restarts.

Frequency-Analysis (FFT) To monitor vibration in the frequency domain the M14 calculates the frequency spectrum of acceleration. In the 500-line spectrum, ten frequency ranges with individual limit values can be determined. This enables selective frequency monitoring from among a mixture of vibration frequencies.

Alarm Relay Besides its capabilities as a measuring instrument the M14 can also trigger switching operations when a specific value of a selected vibration quantity is exceeded. For this purpose it possesses two relays with isolated contacts for warning and alarm. Response threshold, response delay and hold-time can be set via the interfaces.

The relay can also be configured for low-latency monitoring

of instantaneous values.

Level Indicator The LED bar indicator shows the modulation of the monitored vibration quantity between 10 and 100 % of the specified alarm threshold. The indicator remains green until it reaches the warning threshold, upon which it turns red.

AC-Output At the connection terminals there is the analogue sensor signal which is multiplied by the selected gain and a factor 0.4, but unfiltered. The adjusted transducer sensitivity has no influence at the AC output.

The output can be useful for function checks or for a qualitative evaluation of the sensor signal using data loggers and analyzers.

Overload Indicator At the front there is an OVL LED, which signals overload after the input stage and at the outputs of amplifier and integrator. When it starts to light up, the signal has reached the measuring range limit.

Sensor range The LED "IEPE" indicates the condition of the sensor. If it lights up yellow, the sensor is fine. Red means either that the sensor circuit has been interrupted or that the input has been short-circuited. These states are detected from the sensor bias voltage at the input. The valid range is between 1 and 20 V.

Power Supply To operate the M14 requires a DC voltage between 8 and 30 V. The current consumption is below 100 mA. The higher the supply voltage, the lower the current. The supply voltage can be fed through the terminals or the bus connector at the back of the instrument (see figure 3 on page 1).

Interfaces The M14 possesses two digital interfaces for parameter setting and measuring. A mini USB Socket is located at the front. The instrument communicates in virtual COM port mode via ASCII commands. Parameter and measuring software for Windows PC's is available (see section 6.2).

Furthermore there is a 485-interface at the back, which likewise functions with ASCII-commands. Up to 32 instruments can be operated on one interface. The addressing is via the serial numbers. One advantage of the RS-485 standards is that you can use simple two-wire cables with a length of several hundred meters. Apart from this the interface is widespread in control engineering.

4. Installation

4.1 Selecting the Measuring Points

Sensor Attachment Before putting the instrument into operation, suitable measuring points on the machine must be found. For this it is advisable to call upon personnel with experience in machine monitoring.

The forces arising from vibration are normally transferred across bearings and bearing housings to the machine housing. That is why bearing housings or their immediate surroundings are preferable measuring points. Light or mechanically flexible machine parts are unsuitable as measuring points.

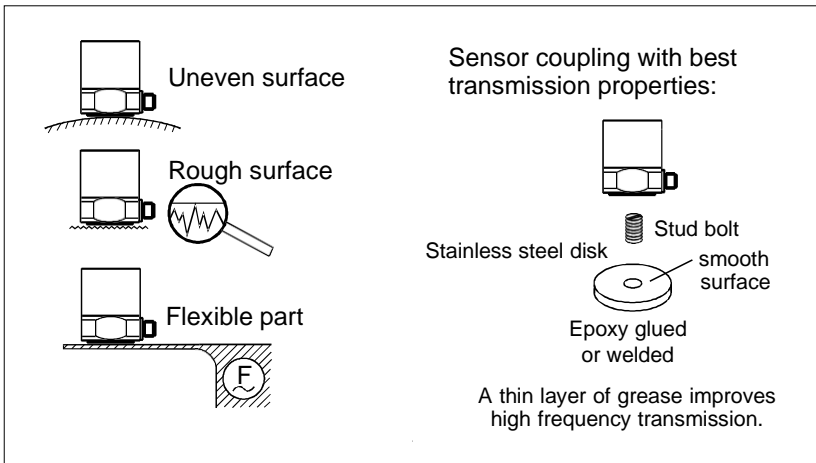

Figure 4: Recommendations for sensor coupling



A flat connection between the sensor and the measuring object is indispensable for an accurate vibration transfer. Uneven, scratched or too small coupling surfaces cause measuring errors, especially in the frequency range above 1 kHz.

For optimal transfer conditions we recommend sticking or welding a small steel measuring disk with an even coupling surface (e.g. model 229 from Metra). The diameter should be at least the size of the accelerometer base.

The sensor is usually attached with stud screws. A thin greasy film (e.g. silicone grease) improves the quality of the connection.

For temporary measurements of vibration severity, clamping magnets are a suitable means of coupling the sensor.

DIN/ISO 20816-1 The standard DIN/ISO 20816-1 recommends bearing housings or their immediate surrounding as preferable measuring points for machine vibration (figure 5 to 8).

For routine monitoring it is often sufficient to measure either in the vertical or horizontal direction. In the case of machines with horizontal shafts and rigid foundations, greater vibration amplitudes occur horizontally. With machines that have been positioned more flexibly strong vertical components can arise. For acceptance tests vibration should be measured in all three directions (vertical, horizontal and axial), on all bearings.

The following illustrations show some examples of suitable measuring points.

Recommendations for measuring points on various types of machine can also be found in the standard ISO 13373-1.

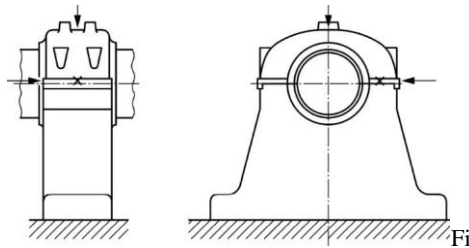

Figure 5: Measuring points on pillow blocks

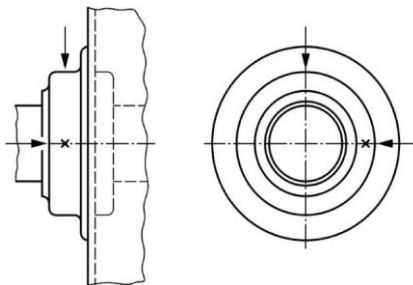

Fig. 6: Measuring points on end shield bearings

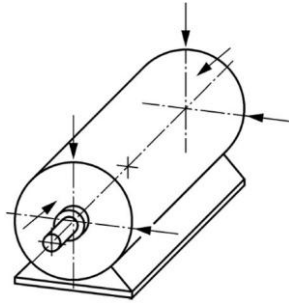

Figure 7: Measuring points on electric motors

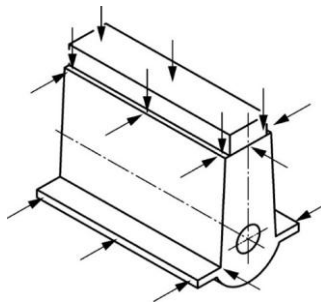

Figure 8: Measuring points on reciprocating machines

4.2 Attachment

The M14 is designed for attaching to a 35 mm DIN rail, which needs to be mounted horizontally. The instrument should be installed in a dust-free moisture-proof environment, preferably in a switch cabinet.

Due to its small width of 12.5 mm the M14 doesn't require much space in the switch cabinet.



Do not position any sources of electromagnetic fields in the immediate vicinity of the instruments, such as clocked power supplies or frequency converters. Otherwise interference with the measuring signal may occur.

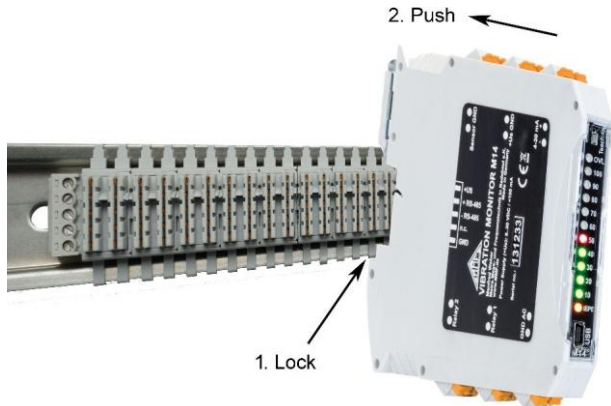

Figure 9: DIN rail attachment with bus connector

DIN-Rail
Bus Connectors

With the bottom notch at the back of the instrument the module slides on to the DIN-rail and is locked in place (see figure 9). The image shows a DIN-rail with bus connectors for RS-485 and supply voltage. The bus connectors M14-BUS (Figure 11) are slotted into each other sideways and clipped on to the DIN-rail. When locked in place all the supply voltage connections and RS-485-interfaces of all the modules are connected with each other, which significantly simplifies the wiring. The terminal configuration of the bus connectors is shown in figure 2 on page 1.



Figure 11: Bus connector M14-BUS



Figure 12: Bus termination M14-BUS2



Figure 10: Connection terminal M14-BUS1

One bus connector M14-BUS is included with the instrument

and as with the connection terminal M14-BUS1, can be used for transfer to cables (Figure 10). It can also be ordered separately. A bus termination M14-BUS2 is needed on the right end of the row. It includes a 120 Ω termination resistor.

The M14 is dissembled by pulling out the metal sliding lock at the top with a screw driver.

4.3 Connection

Terminals All connections are executed as cage clamp terminals. The wire range is 0.2 to 2.5 mm² or AWG 24-14 for single wired and flexible cables.

The configuration of the connection terminals is shown in figure 3 on page 1.

Supply Voltage The M14 requires DC voltage between 8 and 30 V for operation, which is usually available in switch cabinets. 24 V power supply units are well suited for DIN rail installation. The negative terminal of the supply voltage is connected with signal ground. Power consumption is between 25 and 80 mA depending on the supply voltage. The M14 is protected against false polarization and short over-voltage transients. When the instrument is supplied via the DIN rail bus connectors (see section 4.2), the supply terminals remain unconnected.

Sensor Input The M14 is suitable for connection with all types of accelerometers to IEPE standards. The built-in constant current source for the sensor electronics delivers approximately 4 mA. A compliance voltage of 24 V ensures a full dynamic input range independent of the sensor bias voltage. The constant current source is activated by an interface command (see section 6.2.3). This can be useful when non-IEPE signal sources are connected or when two M14 are being operated with one sensor, whereby the power supply should only be provided by one instrument.

The IEPE sensor circuit is monitored. The LED “IEPE” lights up red when the circuit is interrupted or shorted and is yellow under normal operation. A sensor error signals the alarm status at the relay output and offsets the current loop in to the overflow (24 mA).

IEPE compatible piezoelectric accelerometers with sensitivities between 0.8 and 12 mV/ms⁻², that is 8 to 120 mV/g, can be connected to the M14. The sensitivity is entered via the interface (see section 6.2.3).

The M14 input is protected against surge impulses. The vibration sensor is connected up with a coaxial cable or a multi-core shielded cable. Cable lengths of 100 m or more are permissible. Limits are determined by electromagnetic interference and cable capacitance.

👉 Important: please ensure that the sensor ground and sensor signal are never mixed up when connecting! This leads to immediate irreparable damage for many sensors. Please get in contact with the manufacturer if you require assistance when assigning the cables.

👉 Ground loops can cause noisy signals. In order to prevent this you should preferably use accelerometers with insulated housing or ensure isolated mounting on the machine.

Relay Outputs The M14 has two relay outputs, which are usually used for pre-alarms (warning) or the main alarm. The M14 uses solid-state PhotoMOS relays with a switching capacity of 60 V AC and 0.5 A. The switch contacts are galvanically isolated from the rest of the circuitry. They can be parameterized as normally open or closed contacts (see section 6.2.6).

Current Loop The vibration acceleration or velocity being monitored can be selected as RMS or peak value for the current loop. The advantage of 4-20 mA loop signals lies in its robustness which allows the use of inexpensive shielded two-wire cables across distances of up to several kilometers.

The minimum current of 4 mA corresponds to the zero point of the vibration quantity. The maximum current of 20 mA is the alarm limit value, which corresponds to 100 % on the LED-bar indicator (see section 6.2.6). A vibration level belonging to a specific loop current (S) is calculated as follows:

$$S = \frac{A \cdot (I_{loop} - 4 \text{ mA})}{16 \text{ mA}}$$

A is the selected measuring range.

The loop output is isolated from the rest of the instrument.

The current loop output works as a sink, this means that in the measuring circuit a DC voltage source is required. Figure 13 demonstrates this principle. The loop circuit of the M14 needs a voltage of at least 8 V over the terminals (+) and (-). As a result the voltage source U_S is construed as $U_S > 8 \text{ V} + U_L$. U_L is the voltage drop for all the resistance contained in the loop at 20 mA.

With overload or sensor error the loop current becomes 24 mA.

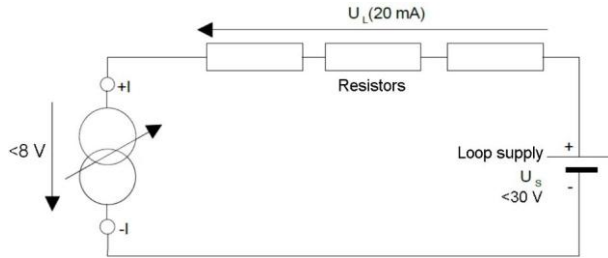

Figure 13: 4-20 mA Loop

 **AC Signal Output**

The voltage at the terminals +I and -I must not exceed 30 V. The signal output provides the amplified, unfiltered sensor signal. It can be used for connecting data loggers and analyzers or for function tests. The maximum output amplitude is $\pm 2\text{ V}$. The frequency bandwidth is over 100 kHz.

5. Indicators

Overload If overload LED “OVL” lights up, the gain should be lowered. In auto-ranging this happens automatically.

If the overload indicator flashes this does not necessarily mean, that the RMS or peak value is too high. It may occur that the signal from the sensor contains dominant parts outside of the filter pass band, which overload the analog or digital signal path. The overload indicator of the M14 monitors the amplifier output as well as the amplitudes before and after filtering or integration.



When communicating via the RS-485 or USB interface the “OVL” flashes briefly to indicate which M14 has just been addressed. This does not mean an overload.

Bar Indicator The 10-level LED bar shows the height of the RMS or peak value (according to the monitoring quantity) referred to the alarm limit in steps of 10 %. When all LED’s light up this corresponds to 100 % of the alarm limit.

In FFT monitoring mode the LED bar shows the amplitude of the largest spectral line in percent referred to the alarm limit of the belonging frequency interval.

Above the warning limit the LED’s light up red instead of green.

IEPE-LED The LED “IEPE” lights up red at interruption or short circuit of the sensor cable and yellow under normal operation.

Version M14B has a multi-color “IEPE” LED which is yellow under normal condition, turquoise at sensor short circuit and purple at cable interruption.

Optional Current Loop Display The vibration level display M12DIS is available as an optional accessory for M14. It enables the numerical display of the measured vibration quantity. Depending on the M14 setting this can be RMS or peak value of vibration acceleration or velocity. M12DIS is a 3 ½ digit LCD digital display module for connecting to the current loop output of the M14. The display is powered by the 4-20 mA loop. Backlighting can be activated by a separate supply voltage.

The connection is made as explained in section 4.3 at the current loop output of M14. The display module uses the screw terminals I+ and I-. It causes a maximum voltage drop of 6 V in the loop. Additional measuring instruments can also be powered from the current loop, as long as the loop supply voltage is high enough to guarantee the minimal voltage drop of 8 V. The 24 V-supply voltage of the M14 can also be used to power the loop.

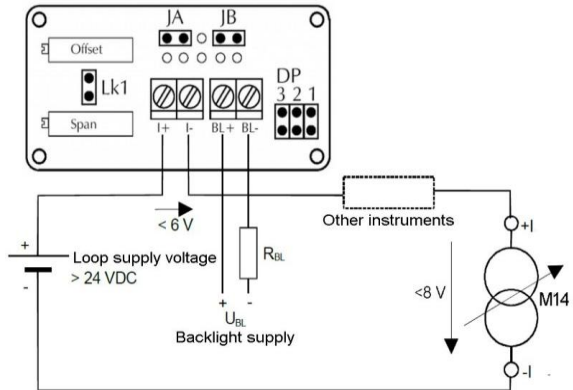

$$R_{BL} = \frac{U_{BL} - 5 V}{30 \text{ mA}}$$

Figure 14: Current loop instrument M12-DIS

If desired LED background lighting can be switched on. This requires a separate DC voltage U_{BL} , which is applied via a series resistor R_{BL} on the $BL+$ and $BL-$ terminals. The current requirement is 30 mA.

The series resistor is calculated as follows:

$$R_{BL} = \frac{U_{BL} - 5 V}{30 \text{ mA}}$$

If the supply voltage U_{BL} is $5 V \pm 0,25 V$, the series resistor R_{BL} can be omitted.

The display module can be attached to front panels, switch boards, switch cabinet doors and other flat objects. For this purpose a mounting bezel is supplied with the M12DIS. The following drawings show the dimensions of the opening and how the display is mounted.

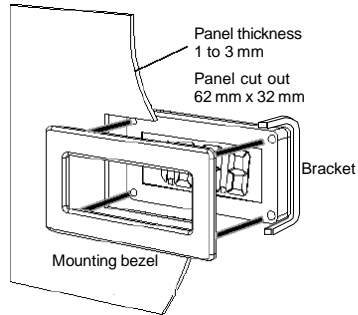

Figure 15: Panel cut out

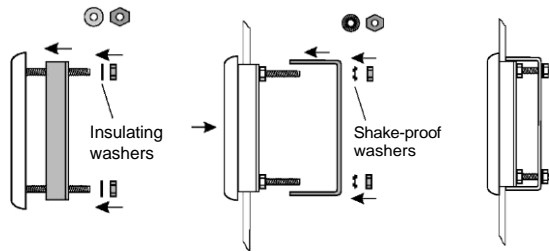

Figure 16: Display mounting

If not otherwise specified when ordering, the M12DIS is supplied with a factory calibration to display “0” at 4 mA and “1000” at 20 mA.

For re-calibration the potentiometers “span” (full scale) and “offset” (zero) are used.

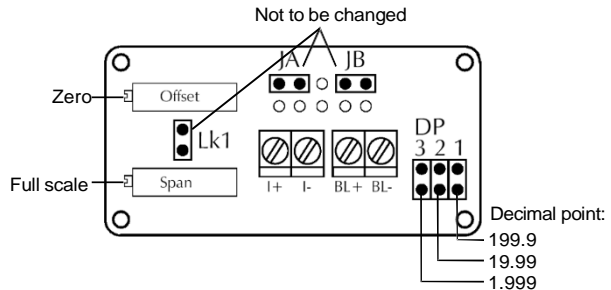

Figure 17: Calibration Points

The M12DIS is calibrated either directly by an adjustable 4-20 mA constant current source or together with the M14. For calibration with the M14 a vibration reference signal is fed into the accelerometer or a generator signal is applied to the M14 input, as explained in chapter 10. Preferably a vibration calibrator should be used to eliminate errors by calibrating the entire measuring chain. The M14 must be calibrated before calibrating the display. The measuring range of the M14 needs to be selected so that the current loop provides at least 50 % (12 mA) of the full-scale level.

After applying the calibration signal, adjust the display to the reference level, for instance "1000" for 10 mm/s, using the potentiometer "Span".

Switch off the calibration signal and adjust the zero display using the potentiometer "offset".

Repeat the calibration of span and offset alternately a few times until both settings are correct.

Finally the position of the decimal point is set by means of jumpers DP1, DP2 and DP3, see Figure 17.

6. Settings

6.1 General

The M14 settings are configured via the digital interfaces RS-485 or USB. On the instrument itself there are no adjusting points. In the following sections the settings will be demonstrated with the software for setup and measurement, available on our software download web page.

The settings can also be adjusted via the RS-485-interface, for example from an PLC or via USB by means of custom-made software using the published ASCII-commands.

6.2 Program for Setup and Measurement

6.2.1 Installation

Instrument Driver Once the supply voltage has been applied, connect the M14 to the PC via the mini USB socket at the front of the instrument. In newer versions of Windows no driver installation will be needed.

If Windows should ask for the instrument driver you can download the file “MMF_VCP.zip” from

<https://mmf.de/en/produkt/m14>

Unpack and save both of the data files to a folder on your computer. Select this folder when Windows requests the driver source. The instrument driver is signed and runs under Windows XP, Vista, 7, 8 and 10.

The driver installs a virtual COM port on your PC and works in CDC mode, which allows simple control using the ASCII-commands.

Once you have installed the driver the M14 will be recognized by the system.

PC Software Installation On our software download web-page:

<https://mmf.de/en/produkt/m14>

you can download our free program for parameter setup and measurement. The program is based on LabView 2014. Upon request we will grant you access to the project data as a basis for your own LabView projects.

Unzip the file m14_pc.zip into a folder on your PC and start *setup.exe*. You can change the installation directory later if desired. The LabView application contains several components of the LabView run-time environment from National Instruments. You will find the installed program in the start menu of your computer under *Metra Radebeul*.

6.2.2 Settings Menu

The program is divided into three subsections each with its own tab:

- Settings (setup), opens after startup
- Measurement in time domain (RMS/Peak)
- Measurement in frequency domain (FFT)

Figure 18 shows the setup view, where you can adjust all M14 settings. The settings will be explained next.

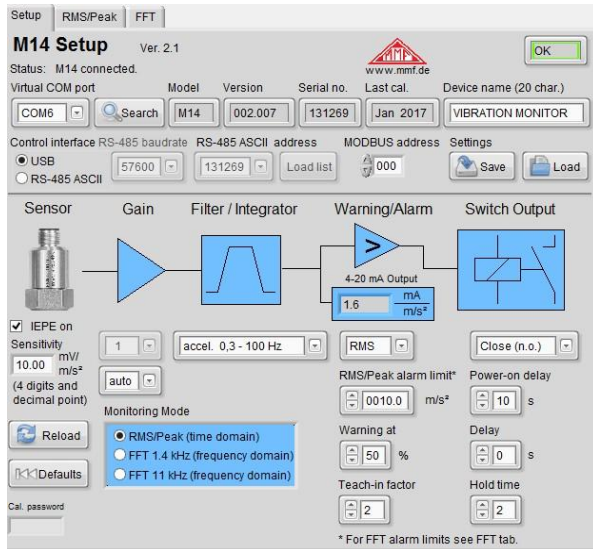

Figure 18: Settings

USB connection In the upper area of the window you will find all details of the connected instrument. Click “USB” and select the number of the virtual COM port which was assigned to the M14 device. Now the settings from the M14 will be transferred to the PC software.

RS-485 connection Alternatively the software can also communicate with the M14 via the rear-side RS-485 bus. For this purpose a commercially available USB-to-RS-485 converter is needed. Select “RS-485 ASCII” and enter “000” in “MODBUS address” (compare section 9.4).

The M14 units at the bus are addressed by their serial numbers. Select the corresponding number from the menu “RS-485 ASCII address“. The serial numbers in this menu can be imported from a text file by clicking “Load list“. This text file can be created in a text editor. It only contains the 6 digit serial numbers, each one in a new line.

After selecting the serial number you select the COM port of the RS-485 adapter. Now the settings from the M14 will be transferred to the PC software.

The software uses the following COM port settings: 57600 baud, 8 data bits, 1 stop bit, no parity, no flow control.

Instrument Data You will see the version, serial number, last date of calibration and the instrument name. You can change the instru-

ments name by overwriting it.

A steady connection to M14 is indicated by the green framed “OK”. If the instrument fails to be recognized (“ERROR”), click “search” to restart the search. In this case it may be necessary to briefly unplug the USB cable.

**Saving and
Loading
Settings**

The buttons “Save” and “Load” are for saving and loading the settings on your PC. The location and data name can be entered in the data dialogue box. The settings are saved in XML format and are automatically transferred to M14 when you load them.

**Standard
Settings**

Click “Defaults” to revert to factory settings.

All entries are sent to M14 immediately after the mouse pointer leaves the entry.

To check if the operation has been successful, click on “Reload”, which uploads all the settings from M14 to the PC program.

6.2.3 Sensor Settings

IEPE Supply The M14 is designed for connection with an IEPE compatible accelerometer. In Figure 1 on page 3 you will find the connection terminals for the sensor.

Sensitivity

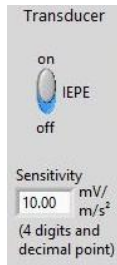

An IEPE sensor requires a constant current source for supplying the sensor electronics. The constant current can be switched off if not needed (Figure 19). This applies when an IEPE sensor is attached to two M14 inputs at the same time, with only one instrument supplying the current or when there is a AC voltage signal at the input instead of an IEPE sensor.

The M14 is suitable for acceleration sensors with a sensitivity between 0.8 and 12 m/s². The sensitivity is stated in the calibration or data sheet of the sensor. Please make sure that the value is entered with the correct unit of mea-

surement (not in mV/g). The sensitivity should have four digits with a decimal point.

6.2.4 Gain



Before analog-to-digital conversion the sensor signal passes an analogue amplifier. The gain factor is switchable between 1, 10 and 100. Alternatively the instrument can adjust the gain automatically (“auto”) to the signal level, which is appropriate in most cases.

Figure 20:
Gain

6.2.5 Filter and Integration

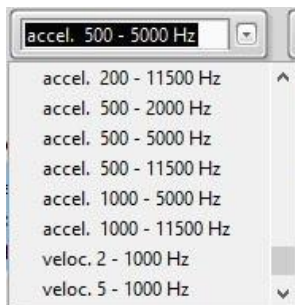

Figure 21: Filters/Integrators

The M14 possesses a number of high and low pass filters.

The filters are 2nd order IIR digital filters. The specified frequencies are -3dB values.

An integrator can be activated for measuring vibration velocity.

6.2.6 Settings for Relay Outputs

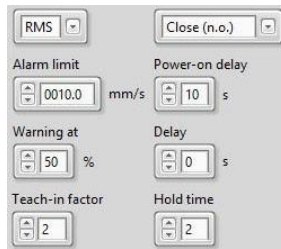

Figure 22: Relay settings

The M14 has two relay out-puts for warning (1) and alarms (2). The connectors are shown in Figure 3 on page 1.

The function of the relay out-puts differs depending on whether you are monitoring in time or frequency domain. Next we will explain the settings in time domain (RMS/peak).

Alarm Limit Below “Alarm limit” enter the limit value, at which the alarm relay should switch. The entry should have four digits before the decimal point and one after it in m/s^2 , that is mm/s (for integration).

Warn Limit Below “Warning at” select a percentage value between 10 and 90 %, referring to the alarm limit at which the warning relay should react.

Switching Mode By selecting RMS/peak you can determine whether the alarm limit is interpreted as RMS or peak value.

Delays You can choose whether the relay opens (“n.o.”, normally open) or closes (“n.c.”, normally closed) when the alarm is signaled. Selecting “n.c.” enables a self-monitoring function of the M14 supply voltage, as well as the relay cabling, This happens because in both cases the relay circuit opens when interrupted, thereby signaling an alarm.

The time response of the relay outputs is determined by three parameters. Under “Power-on delay”, enter the time from 0 and 99 seconds after which the relay outputs become activated, once the supply voltage has been connected.

Below “Delay”, enter the time t_d from 0 to 99 seconds, for the duration of which, the alarm condition must persist before the relay switches. If the signal already falls below the alarm limit before the delay is over, triggering will not occur. “old time” determines the minimum hold time t_h of an alarm’s switching status from 0 to 9 seconds. Figure 23 displays the effect of both delay times in a graph.

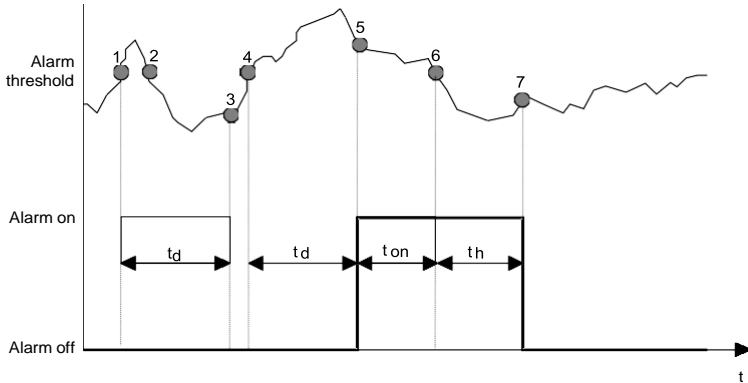

Figure 23: Alarm triggering

The upper section of the diagram displays the progress of a signal which can represent RMS or peak values, the lower section shows the switching state of the alarm relay.

At time point ① the alarm threshold has been exceeded. Now the alarm delay time t_d begins. Due to the fact that at point ② the signal level already falls below the alarm threshold, before the delay time elapsed, the alarm will not be triggered after the set delay time t_d point ③. This guarantees that the occurrence of short limit value exceedance, such as, when starting up the machine, in the case of electrical switching interference or shock impact on the measuring point, does not trigger the alarm, if the appropriate delay time has been selected. At point ④ the alarm threshold has once again been exceeded and the delay time starts anew. This time the alarm has been triggered because after the time t_d has elapsed at reaching time point ⑤ the alarm threshold is still being exceeded. The alarm is now active until time point ⑥ when the alarm level falls below the threshold. Now the alarm hold time begins t_h . After the hold time elapses at ⑦ the alarm goes off. The aim of a fixed minimum hold time is that safe switching of connected external components, e.g. electric contactors, is guaranteed.

To avoid false alarms after switching on the supply voltage, a start-up delay can be set, during which the relay output is inactive.

Low-Latency Monitoring of Instantaneous Values

In some applications a short response time of the relay outputs is crucial. This may be the case, for example, in emergency shut-down installations to avoid damage.

The M14 relay output can be set for response times in the range of some milliseconds after tripping the alarm limit. In this mode the instantaneous value of the vibration is monitored instead of RMS or peak values. It is activated by choosing peak monitoring with “Delay” set to zero. To reach short-

**Relay at
Overload and
Sensor Error**

est response times it is recommended to use fixed gain instead of auto-ranging (see page 19).

At overload of the signal path (LED “OVL”) and error in the sensor circuit (LED “IEPE”) both relay outputs switch to alarm status. The entered delay and hold times also apply for this type of alarm.

The parameter “teach-in factor” is explained in chapter 8.

6.2.7 4-20 mA Current Loop

The current loop output, for which the connections are shown in Figure 1 on page 3, is coupled to the alarm limit. When the limit value has been reached the loop current is 20 mA. The current still continues to flow to reach 24 mA proportional to the vibration amplitude. Furthermore, at overload the output

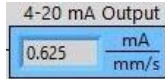

Figure 24:
4-20 mA loop

remains at 24 mA. The resultant transfer factor is then displayed in the PC software (Figure 24).

**Current Loop
for FFT**

When monitoring in frequency domain the limit value comparison takes place frequency dependent by means of the limit value line (see section 7.2). The related limit value of the greatest spectral line corresponds to a loop current of 20 mA. The amplitude of the spectral line, referred to the limit value, determines the loop current.

Example: the greatest spectral line is 300 Hz with an amplitude of 10 m/s². The limit value line determines a limit value of 20 m/s² for 250 bis 350 Hz. This results in a loop current of 12 mA.

6.2.8 Monitoring Modes

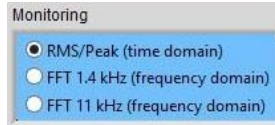

Figure 25:
Monitoring mode

In this menu you can determine whether the M14 should monitor RMS and peak values or operate as FFT monitoring device (Figure 25). Alternatively, you can switch to the tabs “RMS/peak” or “FFT” in the PC software.

The selected mode remains active when the USB cable is unplugged from the M14 or when it is disconnected or re-connected to the power supply.

7. Measuring Functions

7.1 Measuring RMS and Peak Values

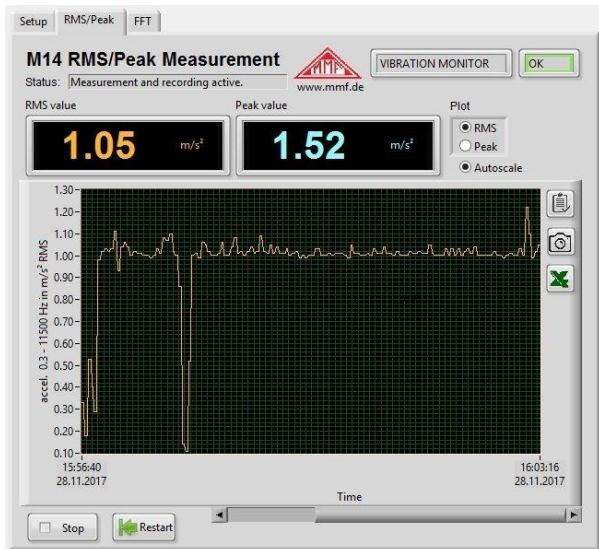

Figure 26: Measuring RMS and peak

In addition to monitoring limit values the M14 can provide measurement values. These can be used, for example, to retrieve the current vibration level with via PLC with a web browser. In the PC software you will find the measurement value display under the tab RMS/peak (figure 26).

Measuring RMS and Peak Values

In the upper section of the measuring window you can see the current RMS and peak values. With a high pass frequency of 0.3 Hz a measurement value is recorded every 2.8 seconds, and with all other high pass frequencies every 1.4 seconds.

At overload, "OVER" is displayed instead of a measurement value.

Plotter The time history of the RMS or peak value is displayed in a graph. You can select the quantity for recording at the top right of the screen. You can also choose whether the amplitude axis should automatically adjust to the signal ("Autoscale"). Further scaling options, including the time axis, are available by right clicking on the diagram. Similarly, you can re-scale the axis by editing the number values of the axis label. This can be useful, for example, when skipping to a specific time point.

Press "Stop" to end the recording. "Restart" begins a new recording, and deletes the contents of the previous diagram.

Data Export To export the diagram data or the graph you can copy it to the clipboard or transfer the data as a table to an Excel diagram.

7.2 Frequency Analysis

Frequency Analysis Click on the “FFT” tab to start the frequency analysis (27).

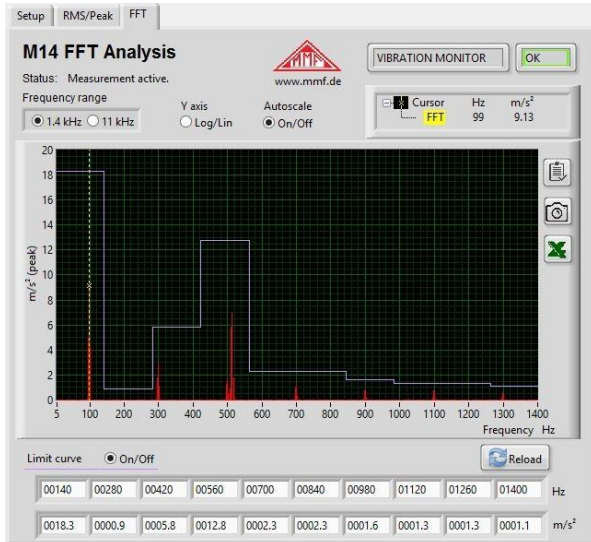

Figure 27: Frequency analysis

The diagram displays a 500 line spectrum.

Two bandwidths are available to choose from:

- 5 to 1400 Hz
- 50 to 11000 Hz

The cursor rests on the largest spectral line. Frequency and amplitude are visible in the top right corner. You can move the cursor with the mouse by clicking on and dragging the yellow dotted line.

The amplitude axis can be switched between the linear and logarithmic view. Below the diagram you will find 10 entry fields each for both frequency and amplitude, with the help of which you can define a step-form limit value line.

The frequency points can be selected as desired within the limits of the frequency range. The only condition is that the frequencies should ascend from left to right. The amplitude below the frequency applies until the next greater frequency. The tenth amplitude applies until the upper limit frequency.

You can hide and show the limit value line on the diagram, without it having any influence on the M14. This compares the spectral lines in FFT monitoring mode with the limit value belonging to each frequency. When the limit values are exceeded the alarm relay switches, or if the percentage warn-

ing limit is exceeded the warning relay switches. As with RMS/peak the delay times programmed under “Setup” apply.

When overload occurs, “Overload!” will appear on the diagram.

Data Export To export the diagram you can copy the diagram data or the graph to the clipboard or transfer the data as a table to an Excel diagram.

8. Teach-in-Function for Alarm Limits

With the help of the teach-in function the M14 can determine the alarm limit automatically on the basis of the currently pending vibrations.

At first, enter the teach-in factor under “Setup”. This is the factor, by which the measured amplitude is multiplied, in order to determine the alarm threshold (figure 28). The factor may lie between 1 and 9.

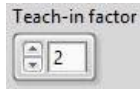

Figure 28: Teach-in-factor

The teach-in process begins by pressing the button at the front of the instrument (figure 1, page 1). Press the button for a full 5 seconds, during which all the LEDs of the bar indicator will light up red. Release the button as soon as the LEDs go out. Now the teach-in process will start.

RMS-/Peak-Teach-in When measuring RMS/peak the new alarm limit is calculated immediately after the red LED bars go out.

FFT-Teach-in When measuring FFT the teach-in process takes slightly longer. It is signaled by the bar LEDs lighting red and green alternately. During the teach-in phase the vibration signal has to be representative of the monitoring task, and stable. In order to avoid distortions the accelerometer should not be touched. The teach-in process is completed after 15 to 30 seconds and the instrument reverts to monitoring operation. The LED bar should then display around 100 % divided by the teach-in factor.

In FFT mode 10 frequency/amplitude pairs form the limit value line. The frequency range of 1.4 or 11 kHz is subdivided into 10 equally broad frequency bands. In each frequency band the limit value is determined by the amplitude of the greatest spectral line, multiplied by the teach-in factor. If the greatest spectral line lies on the border of an interval, the neighboring interval will be set at the same limit value. Teach-in starts with an FFT band width of 11 kHz. If frequency of the resulting maximum amplitude is lower than

800 Hz, the measurement will be repeated once 1.4 kHz band width.

You can check the result of the teach-in process in the PC software by reloading the settings (“Reload”).

9. Interfaces and Protocols

9.1 Overview

Metra provides all necessary information for software integration via USB and RS-485. The subsequent lists contains all commands for both interfaces.

As a basis for integration into LabView we provide the project data for the setup and measurement program (see section 6.2). As a template for PLC applications the WAGO project data m14.ecp is available on demand.

9.2 USB Communication in CDC Mode

Commands The commands and the answers are ASCII strings. Line break symbol is <CR>.

The return always ends with /a + <LF> or at errors with /n + <LF>.

Instruments **Name** **#Bnnnnnnnnnnnnnnnnnnnn**: write instrument name
n: Name, 20 characters (capital letters, numbers ,spaces)

Date of Calibration **#Cmmyy**: write calibration date
m: month (01-12), 2 digits
y: year (last 2 digits)

Set Calibration Values **#Dncccc**: write calibration values
n: calibration value index;
A = amplitude calibration value;
B = 4-20 mA loop – zero point;
C = 4-20 mA loop end value
c: calibration value, 06000 to 14000 (5 digits)

Measuring Mode **#Em**: set measuring mode
m: 0 = RMS and peak measurement, fetch with #M
1 = FFT with 1.4 kHz band width, fetch with #H
or main frequency and amplitude, fetch with #N
2 = FFT with 11 kHz band width, fetch with #H
or main frequency and amplitude with #N

Filter and Integrator **#Fhhli**: Filter for RMS and peak measurement
 h: high pass filter index (2 digits),
 at acceleration: 00 = high pass off or FFT; 01 = 5 Hz;
 02 = 10 Hz; 03 = 20 Hz; 04 = 50 Hz; 05 = 100 Hz;
 06 = 200 Hz; 07 = 500 Hz; 08 = 1000 Hz,
 at velocity: 00 = 2 Hz; 01 = 5 Hz; 02 = 10 Hz
 l: for acceleration low pass filter index or for velocity second
 high pass filter index (2 digits),
 for acceleration: 00 = 0,1 kHz; 01 = 0,2 kHz;
 02 = 0,5 kHz; 03 = 1 kHz; 04 = 2 kHz,
 05 = 5 kHz; 06 = 11,5 kHz
 for velocity: 00 = 2 Hz; 01 = 5 Hz; 02 = 10 Hz
 i: integrator (a or v for acceleration or velocity)

Gain **#Gg**: Set amplifier
 g: gain (1 digit), 0 = 1; 1 = 10; 2 = 100;
 3 = PGA input short circuited; 4 = auto

Read FFT **#H**: fetch FFT
 Return:
 aaaa.a
 ... 500 lines of data
 aaaa.a
 a: Amplitude in m/s² (5 digits with amplification dependent decimal point)
 with USB: acknowledgment of command: /a
 with RS-485: last byte = checksum of all bytes
 output example: 0000.0
 0000.0
 0003.4
 0012.1
 ...
 0000.0
 0000.0#
 /a
 at overload: OVERLOAD
 /a
 error message with USB, if not in FFT mode (#E1 or #E2): /n
 Attention: For sending the command via RS-485 a number from 1 to 5 has to be sent after #H. This is the number of one of five FFT segments with 100 lines each.

Factory Reset **#l**: Revert to factory settings

Teach-in Factor **#Kx**: Teach-in factor (factor between measured amplitude and the automatically determined alarm threshold when pressing the button), x = 1 ... 9
 Note: When the measured amplitude for teach-in is zero, the teach-in factor is placed as a decimal of the alarm threshold.
 Example: Teach-in factor = 2; alarm threshold = 0.2

Alarm Threshold **#Lmxxxx.x**: Set alarm threshold
m: r = RMS; p = peak
x: alarm threshold; 5 digits; 0.1 to 6000.0; with decimal point before the last digit
E.g.: #Lr0012.0 (RMS, 12.0 m/s²)

Read RMS and Peak Values **#M**: Fetch RMS and peak
Return:
rrrrr.r ppppp.p
r: RMS; 6 digits, without leading zeros;
with gain dependent decimal point
p: peak; 6 digits; without leading zeros;
with gain dependent decimal point
peak is the highest measured value since the last sent #M.
output at overload: OVER OVER /a
for RS-485: last byte = checksum
error message for USB, if not in mode #E0: /n
output example: 22.81 23.52

Read Main Frequency and Amplitude **#N**: Fetch main frequency and amplitude
Return: fffff aaaa.a
f: main frequency in Hz (5 digits with leading zeros), spaces
a: amplitude in m/s² (5 digits with leading zeros and gain dependent decimal point)
For RS-485: last byte = checksum
Error message for USB, if not in mode #E1 or #E2: /n
output example: 01200 023.40
/a

FFT Limit Values **#Onffffaaa.a**: limit values for FFT monitoring
 n: limit value number (0 to 9, 1 digit),
 f: frequency in Hz (5 digits),
 a: Amplitude in m/s^2 (5 digits with decimal point before last)
 example: #2015000010.0 (limit 2 at 1500 Hz 10,0 m/s^2)
 The frequencies have to be entered in numerical sequence (the lowest first).
 The entries are only evaluated until the first occurrence of the frequency "00000".
 If the first frequency is "00000" (command #00 00000 0000.0), no FFT monitoring will be performed.
 acknowledgment of command: /a
 error message at invalid or missing character and incorrect sequence: /n
 Explanation of the limit values: the first limit value is valid from 0 Hz. A limit value applies until the frequency of the following limit value. If no further limit value follows or if the subsequent limit value has a frequency of "00000", the limit value applies until the end of the frequency range.

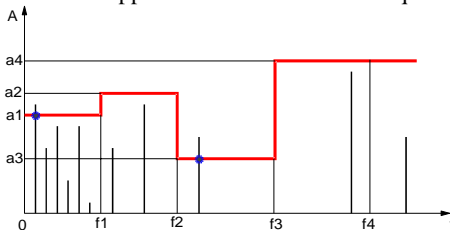

Figure 29: FFT Limit values

RS-485 Baud rate **#Qq**
 q: baud rate: 0 = 9600; 1 = 19200; 2 = 38400; 3 = 57600

Relay Settings **#Raddeeh**: Relay settings
 a: switching mode, 0 = close (n.o.), 1 = open (n.c.), 1 digit
 d: switching delay, 0 – 99 s (2 digits)
 e: power on delay after applying the supply voltage, 0 – 99 s (2 digits)
 h: hold time, 1 – 9 s (1 digit), 0 = latching

Sensor Sensitivity **#Ssssss**: Transducer sensitivity
 s: sensitivity, 4 digits, with decimal point after 1st or 2nd digit
 entry range: 0.800 to 12.00 $mV/m/s^2$
 example: #S10.12

IEPE Supply #Ti: IEPE supply on/off:
i: 0 = off; 1 = on

Warning Limit #Www: Warning limit
w: warning limit in % of the alarm limit (10 – 90 %), 2 digits

Read Settings #X: Read instruments data and settings
Answer:

tttt Ver. sss.hhh Ser. xxxxxx
t: Type code (M14 , 4 characters)
s: software version (3 digits)
h: hardware version (3 digits)
x: serial no. (6 digits)
B: bbbbbbbbbbbbbbbbbbbb
b: instruments name (20 upper case / numbers / spaces)
C: mm yyyy
Cal.-date, m: month* (3 characters), y: year (4 digits))
DA: ddddd
d: amplitude calibration value (5 digits)
DB: ddddd
d: 4-20 mA loop zero point calibration value (5 digits)
DC: ddddd
d: 4-20 mA loop full scale calibration value (5 digits)
E: e
e: measuring mode (1 digit)
F: hhlll
h: high pass index (2 digits)
l: low pass index (2 digits)
i: integrator (0 = a / 1 = v); (1 character)
G: ggg m
g: gain (1 / 10 / 100; 3 s, (with leading space i.a.)
m: f = fixed, a = automatic, z = zero point calibration
(1 character)
K: k
k: teach-in factor
L: xllll.l
x: r = RMS, p = peak (1 character)
l: alarm threshold (5-digits, with leading space i.a.;
decimal point before the last digit)
Www:
w: warning limit (10 to 90 as a percentage; 2 digits)
R: mddooh
m: relay switching mode
d: switching delay
o: power on delay
h: hold time
T:t
t: IEPE supply, 0 = on, 1 = off
O0: ffff aaaa.a
limit values for FFT monitoring
f: frequency in Hz (5 digits)

a: FFT limit value 1 (5 digits, decimal point before last)

...

O9: ffff aaaa.a

S: sssss

s: sensor sensitivity, 4 digits and decimal point

U: uuuuu

u: RS-485 baud rate; 9600 / 19200 / 38400 / 57600

M: mmm

m: MODBUS address; 000 = inactive; 001 .. 247

line break with <CR>

for USB: acknowledgment: /a

for RS-485: last byte = checksum of all previous bytes

MODBUS #Yyyy
Address (RS-485) y: address, 001 to 247
000 = RS-485 in ASCII command mode (no MODBUS)

Detection #Z: Only for instrument detection, always returns /a

9.3 RS-485 Communication in ASCII Mode

By the USB command #Y000 or by entering “000” in “MODBUS address” of the setup program (Figure 30) the RS-485 interface of the M14 is set to ASCII command mode. Thus the described set of USB commands becomes available via the RS-485 interface. In contrast to the USB commands the 6-digit serial number of the instrument has to be inserted after the # symbol. This allows you to address each module individually at the RS-485 bus. A command is terminated with carriage return <CR>.

The data received from the M14 ends with a checksum of all bytes.

Erroneous commands are not answered.

The interface settings are:

9600 / 19200 / 38400 / 57600 Baud

(see USB command #Q or baud rate menu of the setup program)

8 data bits, 1 stop bit, no parity.

Example: #123456G2<CR>

The amplification of the M14 unit with the serial number 123456 is set to 100.

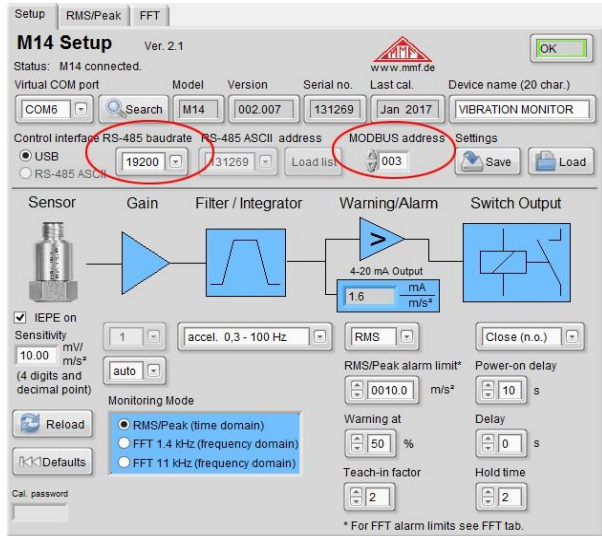

Figure 30: RS-485 settings in the setup program

9.4 MODBUS RTU

Valid from version
00x.011

The RS-485 interface is set to MODBUS mode by entering “MODBUS address” (Fig. 30) in the USB setup program or by using the USB command #Yxxx. The possible range for addresses is 001 to 247. An address must not be assigned more than once on the bus.

If “000” is entered, the RS-485 interface operates in ASCII mode instead (see section 9.3).

The interface settings are:

9600 / 19200 / 38400 / 57600 baud,
8 data bits, 1 stop bit, no parity.

With the MODBUS RTU communication protocol, several M14 modules can be set and read out by a client, e.g. a PC or a PLC.

Data is transmitted in binary format. All measured values and limit values are coded as 32-bit floating point numbers (float or single) in accordance with IEEE 754. The byte sequence is “big-endian”, i.e. the most significant byte is sent first (Figure 31).

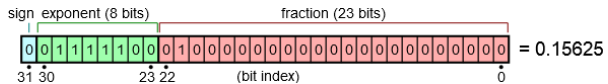

Figure 31: Coding example of the float value 0.15625

A command begins with the 1-byte long M14 address. This is followed by the 1-byte function code (FC) and the register address to be read or written. The M14 only uses the codes 0x03 (read register), 0x06 (write one register) and 0x10 (write several registers).

The data field can vary in length depending on the command and contains the data to be written or read. Each command ends with a 2-byte CRC checksum.

The answer from the M14 also begins with the address of the device and the previously received function code. If an error has occurred, the highest bit in the function code is set to 1.

Data and checksum follow.

At errors the following Exception Codes are returned:

- 0x01: Illegal Function Code
- 0x02: Illegal Address
- 0x03: Illegal Data
- 0x04: M14 error (overload or IEPE error)
- 0x06: Busy (wrong measuring mode or FFT calculation)

The following overview shows the MODBUS commands ordered by register addresses. All numbers are hexadecimal.

0x01: Read RMS and peak values

M14	FC	Address			Length		CRC	
x	0x03	0x00	0x01	0x00	0x04	c	c	

Answer:

x	0x03	0x08	R	R	R	R	P	P	P	P	c	c
---	------	------	---	---	---	---	---	---	---	---	---	---

R: RMS as float (32 Bit)

P: Peak as float (32 Bit)

The peak value is the highest measured value since the last polling.

If the M14 is in FFT mode, exception code 0x06 is returned.

0x10 .. 0x19: Read FFT in blocks

M14	FC	Address			Length		CRC		
x	0x03	0x00	0x10	0x00	0x64	c	c	Amplitude 1 to 50	
			0x11					Amplitude 51 to 100	
			0x12					Amplitude 101 to 150	
			0x13					Amplitude 151 to 200	
			0x14					Amplitude 201 to 250	
			0x15					Amplitude 251 to 300	
			0x16					Amplitude 301 to 350	
			0x17					Amplitude 351 to 400	
			0x18					Amplitude 401 to 450	
			0x19					Amplitude 451 to 500	

Answer:

x	0x03	0xC8	A	A	A	A	...	A	A	A	A	c	c
---	------	------	---	---	---	---	-----	---	---	---	---	---	---

A: 50 amplitudes in m/s^2 (float, 32 Bit) in a frequency grid of 2.8 or 22.35 Hz
Amplitudes 1 and 2 are always zero.

If the M14 is in RMS/peak mode, exception code 0x06 is returned.

0x22: Write filter/integrator

M14	FC	Address		Value		CRC	
x	0x06	0x00	0x22	H	L	c	c

H: High pass filter index

For acceleration: 0x00 = 0.3 Hz, 0x01 = 5 Hz, 0x02 = 10 Hz, 0x03 = 20 Hz,
0x04 = 50 Hz, 0x05 = 100 Hz, 0x06 = 200 Hz, 0x07 = 500 Hz, 0x08 = 1000 Hz,
For velocity: 0x09 = 2 Hz, 0x0A = 5 Hz, 0x0B = 10 Hz

L: Low pass filter index

For acceleration: 0x00 = 0,1 kHz, 0x01 = 0,2 kHz, 0x02 = 0,5 kHz,
0x03 = 1 kHz, 0x04 = 2 kHz, 0x05 = 5 kHz, 0x06 = 11,5 kHz
For velocity: unused

Answer: (as command)

x	0x06	0x00	0x22	H	L	c	c
---	------	------	------	---	---	---	---

0x22: Read filter/integrator

M14	FC	Address			Length		CRC	
x	0x03	0x00	0x22	0x00	0x01	c	c	

Answer:

x	0x03	0x02	H	L	c	c
---	------	------	---	---	---	---

0x41: Read calibration date

M14	FC	Address	Length	CRC
x	0x03	0x00 0x41	0x00 0x02	c c

Answer:

x	0x03	0x04	0x00	M	0x00	Y	c	c
---	------	------	------	---	------	---	---	---

M = month (0 .. 11); Y = year – 2000

0x80: Write device name

M14	FC	Address	Length	Bytes	Device name (20 characters)	CRC
x	0x10	0x00 0x80	0x00 0x0A	0x14	n n n ... n n n n n n n n n n n n n n n n	c c

Answer:

x	0x10	0x00	0x80	0x00	0x0A	c	c
---	------	------	------	------	------	---	---

0x80: Read device name

M14	FC	Address	Length	CRC
x	0x03	0x00 0x80	0x00 0x0A	c c

Answer:

x	0x03	0x14	n	n	n	...	n	n	n	n	c	c
---	------	------	---	---	---	-----	---	---	---	---	---	---

n: device name (20 characters)

Note: Active communication between an M14 and the MODBUS client can be recognized by the flashing “OVL” LED. It flashes for each data packet sent by the M14.

Note: At <https://mmf.de/en/produkt/m14/> you will find a sample PLC application featuring all MODBUS RTU setup and measurement functions of the M14 (Figure 32). The project was developed for a WAGO PFC200 in e!Cockpit/CODESYS3, but can also be ported to other controllers.

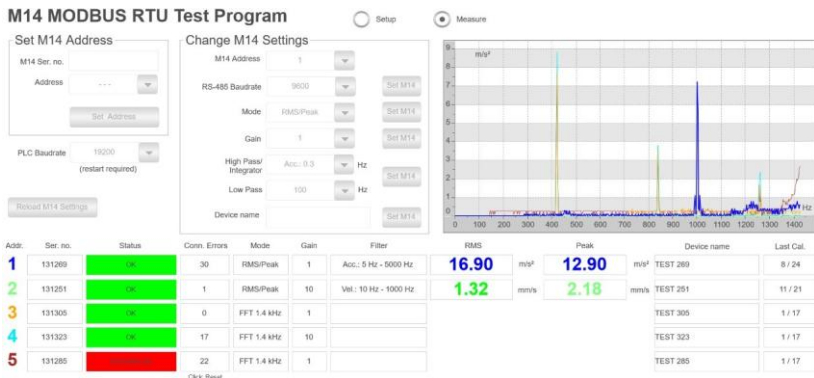

Figure 32: MODBUS-RTU example application

10. Calibration

Re-Calibration The M14 is factory calibrated so that after entering the correct sensor sensitivity (see section 6.2.3) you can accurately measure amplitudes.

Vibration Calibrator The calibration can be carried out in a simply way with a vibration calibrator of the ‘VC’ series from Metra. A precise mechanical vibration signal of 10 m/s² or 10 mm/s with a frequency of 159.15 Hz is fed into the sensor and the measured RMS or peak values of M14 are tested (see. section 7.1).

11. Firmware Update

The instrument software of M14 can be updated via the USB-interface. You can find the version installed on your computer with the help of the setup and measurement program under setup (figure 18 on page 17). The first 3 characters show the hardware version, the second three the software version.

Under <https://mmf.de/en/produkt/m14> you can check whether a newer firmware version exists. Unpack the file m14.zip in a directory of your choice.

Close the setup and measurement program and install the program “Firmware Updater” from the above named website.

Start the “Firmware Updater”, then select the instrument type “M14” and the virtual COM-Port, which the M14 USB interface is connected to.

Click on “Load“ in “firmware updater” and enter the path to the folder, in which the unpacked firmware file m14.hex is located.

Next click on “Send”. The firmware data transfer will now begin. The transfer progress is displayed in a time bar. Once the updates have been completed the M14 starts and “Firmware Updater” is closed. Please do not interrupt the update process. If transfer errors occur you can restart the update.

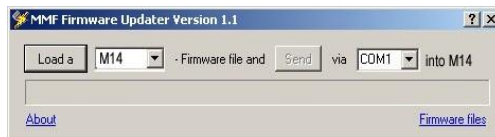

Figure 33: Firmware updater

12. Measuring Machine Vibration

The stationary monitoring of machine vibration as part of predictive maintenance can have a significant impact on cost reduction and avoid unexpected breakdowns.

The evaluation of machine vibration requires a certain degree of experience. At this point we can only enter the subject briefly.

12.1 Measuring Vibration Severity or Unbalance Vibration

The measurement of vibration velocity (vibration severity) is a common technique of monitoring unbalance on rotating machines. Vibration severity measures the energy content of occurring vibrations. Unbalance can be caused, for example, by loose screws, bent parts, worn bearings with great clearance or deposits on fan blades. Often several factors mutually reinforce each other.

DIN/ISO 20816-1 If there is no empirical data available for vibration severity on the machine concerned, you can refer to the zone limit values of DIN/ISO 20816-1. Here you can find recommendations for permissible vibration velocity values for various types of machines in continuous operation (Figure 34). The measurement is commonly carried out between 10 and 1000 Hz.

$v_{\text{eff}} 10 - 1000 \text{ Hz}$	45 mm/s			
	28 mm/s			
	18 mm/s			
	14.7 mm/s			Zone C/D 4,5 – 14,7 mm/s
	11.2 mm/s			
	9.3 mm/s		Zone B/C 1,8 – 9,3 mm/s	
	7.1 mm/s			
	4.5 mm/s	Zone A/B 0,71 – 4,5 mm/s		
	2.8 mm/s			
	1.8 mm/s			
	1.12 mm/s			
	0.71 mm/s			
	0.45 mm/s			
0.28 mm/s				
D	Risk of machine damage			
C	Restricted continued operation			
B	Unrestricted operation possible			
A	Newly commissioned machine			

Figure 34: Zone limit values for vibration velocity to DIN/ISO 20816-1

12.2 Monitoring Roller Bearings

While the procedure shown in in section 12.1 to DIN/ISO 20816 deals with vibration, arising due to unbalance, this section concerns vibration of rolling bearings.

Typical causes of damage to roller bearings are fatigue, corrosion, cage damage, poor lubrication, wear due to too high demands.

The consequences are damage to the raceways (pitting), increased temperature, noise, and clearance, bumpy operation even to cage breakage and total breakdown of the machine.

When rolling over damaged areas impulses arise, which cause the system to vibrate. These vibrations can be measured, on the bearing housing, for example.

The vibrations generated on rolling bearings are normally above 1 kHz. The vibration acceleration is usually recorded.

Damage on roller bearings can be diagnosed in frequency or time domain. Diagnosis in the frequency spectrum delivers more detailed information about the bearings under assessment. It does, however, require a high degree of experience.

The procedure in time domain (RMS and peak of acceleration) provides, on the other hand, more simple results and requires less costly instruments. In the majority of cases they provide sufficient information about the condition of a roller bearing.

Crest Factor A proven procedure in the time range is crest factor measurement. The crest factor is the quotient of the peak and RMS value of vibration acceleration (\hat{a}/a_{eff}). The method is based on the knowledge that at in the early stages of bearing damage, only small changes in the RMS of the vibration acceleration emerge. In contrast, the peak value already rises significantly (see Figure 35).

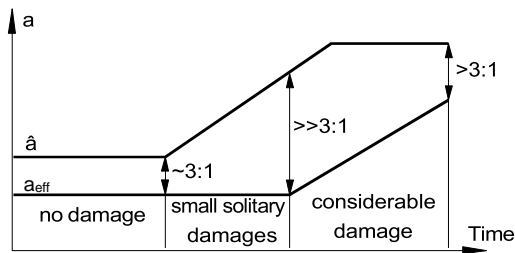

Figure 35: Typical damage progress of rolling bearings

The following table shows the crest factor and alternatively the product of peak and RMS in relation to the degree of damage.

Condition	a_{eff}	\hat{a}	\hat{a}/a_{eff}	$\hat{a} \cdot a_{\text{eff}}$
No damage	small	small	~ 3	small
Minimal single damage	small	increased	>3	slight increase
Several small single damages	increased	increased	>3	medium increase
Greater single damage	increased	high	>>3	increased
Many great single damages	high	high	>3	high

Diagnosis Index to Sturm A further method for monitoring roller bearings in the time range is the diagnostic coefficient $D_k(t)$ according to Sturm. This is calculated from the RMS and peak value of acceleration in a good condition (0) and in the condition at the moment of assessment (t):

$$D_k(t) = \frac{a_{\text{eff}}(0) \cdot \hat{a}(0)}{a_{\text{eff}}(t) \cdot \hat{a}(t)}$$

According to Sturm the following can be found:

$D_k(t)$	Rolling bearing condition
> 1	Improvement
1 ... 0.5	Good operating condition
0.5 ... 0.2	Accelerating influence to the damaging process
0.2 ... 0.02	Progressive damaging process
< 0.02	Damage

13. Technical Data

Measuring Range (1/10 mV/ms ⁻² sensit.)	RMS	peak
vibration acceleration	7000 / 700 m/s ²	10000 / 1000 m/s ²
vibration velocity	7000 / 700 mm/s	10000 / 1000 mm/s
Measuring Error (10 mV/ms ⁻² sensitivity)	RMS	peak
Vibration acceleration	± 3 % at >0.1 m/s ²	± 3 % at >1 m/s ²
Vibration velocity	± 3 % at >1 mm/s	± 3 % at >10 mm/s
Input	voltage input, R _i = 2 MΩ; AC coupled; IEPE compatible	
Sensor Power Supply	3.5 to 4.5 mA constant current, source voltage > 24 V; switchable	
Compatible Sensors	IEPE compatible accelerometers sensitivity: 0.8 to 12 mV/ms ⁻²	
Frequency Range		
Broadband signal at AC-output	0.3 Hz to > 100 kHz (-3 dB)	
Vibration acceleration (digital)	0.3 Hz to 10 kHz	
Vibration velocity (digital)	2 Hz to 1 kHz	
Filter	IIR digital filter; two-pole	
High pass filters	5/10/20/50/100/200/500/1000 Hz	
Low pass filters	100/200/500/1000/2000/5000/10000 Hz	
Gains	1 / 10 / 100 and auto-ranging	
Rectification	True RMS; peak	
Frequency Analysis (FFT)	500 lines; Hanning window; peak spectrum; 5 to 1400 Hz and 50 to 11000 Hz	
Output Rate	1 RMS-/peak-value per 1.4 s at HP >0.3 Hz 1 RMS-/peak-value per 2.8 s at HP =0.3 Hz 1 FFT per 1 s	
Relay Outputs	2 PhotoMOS relays for warning and alarm; 60 V DC/AC; 0.5A; isolated configurable as N.C. contact or N.O. contact	
Trip Level Range of Alarm Relay Response Threshold for RMS/Peak	0.1 to 9999.9 m/s ² ; 0,1 to 9999.9 mm/s	
Alarm Relay Threshold for FFT	10 frequency intervals with one limit each	
Trip Level Range for Warning Relay	10 to 90 % of the alarm threshold	
Trip Delay	1 to 99 s for RMS/peak and FFT adjustable; <20 ms response time for instantaneous value; 0 to 99 s delay after connecting power supply	
Relay Hold Time	0 to 9 s	
4-20 mA Current Loop Output	4 to 20 mA, passive, isolated; terminal voltage: 8 to 30 V;	

output at overload and sensor error: 24 mA

AC Output	acceleration signal; $\hat{u}_a = \pm 3 \text{ V}$; sensitivity: $0.4 \cdot \text{Gain}$; 1 Hz to > 100 kHz; impedance 100 Ω
Sensor Monitoring	IEPE LED at <1 V and >20 V bias voltage; at sensor error 24 mA at 4-20 mA loop and alarm relay set
Overload Indicator	OVL LED, threshold at gain = 1: 10000 m/s ² (Peak); gain = 10: 1000 m/s ² (Peak); gain = 100: 100 m/s ² (Peak); also at overload after filters and integrator
Level Indicator	10-step LED bar indicator; 10 to 100 % of alarm limit; green below warning limit, red above
USB Interface	mini-USB (front); USB 2.0 full speed
RS-485 Interface	via bus connector on rear side; 9600/19200/38400/57600 baud; 8 data bytes; 1 Stop bit; no parity; MODBUS protocol
Power Supply	8 to 28 VDC / <100 mA; protected against false polarization
Terminals	cage clamp; 0.2 to 2.5 mm ² ; AWG 24-14; bus connector on the DIN-rail
Operating Temperature Range	-40 to 60 °C humidity < 95 %, no condensation
Dimensions (W x H x D)	13 x 100 x 114 mm ³
Weight	90 g

24 months

products will be free from defects in material or workmanship and shall conform to the specifications current at the time of shipment.

The warranty period begins with the date of invoice. The customer must retain the original purchase receipt as evidence of purchase.

The warranty period is 24 months.

Repairs do not extend the warranty period.

This limited warranty covers only defects which arise as a result of normal use according to the instruction manual.

The manufacturer's responsibility under this warranty does not apply to

Declaration of Conformity

According to EMC Directive 2014/30/EC and
UK Electromagnetic Compatibility Regulations 2016

Product: Vibration Monitor

Type: M14

It is hereby certified that the above mentioned product complies with the demands pursuant to the following standards:

DIN / BS EN 61326-1: 2013

DIN / BS EN 61010-1: 2011

DIN 45669-1: 2010

The producer is responsible for this declaration
Metra Mess- und Frequenztechnik in Radebeul e.K.

Meißner Str. 58, D-01445 Radebeul

declared by



Michael Weber
Radebeul, November 21, 2022