



# FastTRACER

USB Sensor

## FastTracer 3D Sensor System

- is a user-friendly, cheap and powerful sensor. It joins together the MEMS technology and USB serial port to create a portable high performance sensor capable of processing vibration and acceleration analysis.
- is the portable version of SeTAC: while SeTAC is fixed on machineries for continuous monitoring, giving digital alarms when excessive vibrations are reached. FastTRACER is not bounded to a specific machine. It is a portable analysis instrument.
- enables the PC a higher analysis capacity and speed signal evaluation, excellent data visualization, easy storage of the data, in the way of reducing the analysis time compared to traditional vibration measurement systems
- does not require an external power supply, as it works connected to a Personal Computer via USB. So, it is easy to use in every working contest. A wide selection of real time analysis features and the triaxial sensor capabilities give opportunity to analyse the main vibration phenomena through an easy graphical interface at a very low price.
- is able to extrapolate from acceleration signal some of the derived dimensions (as RMS, module, velocity, FFT) The easy device's programmability allow user to choose which is the most suitable parameter for every kind of analysis. FastTRACER can discriminate desired frequencies by using configurable filters.

## FASTTRACER

- allows to approach the advantages of predictive maintenance. recording the vibration trace of machinery in its different behaviors and during different operating conditions, it is possible to create a vibration database. The easy visualization on a PC screen makes immediate the different behaviors between similar machines, as well as the evaluation of the deteriorating trend of typical spare parts.

## FASTTRACER can be used to:

- visualize the natural vibration frequencies which characterize machines and the waveforms on each axis;
- measure the acceleration, velocity, displacement and unbalancing values during the different working processes;
- record waveforms and the frequency spectrum analysis (FFT) for investigation and historical performances comparison;
- define and use specific values as reference for the tools wear and machine anomalies.

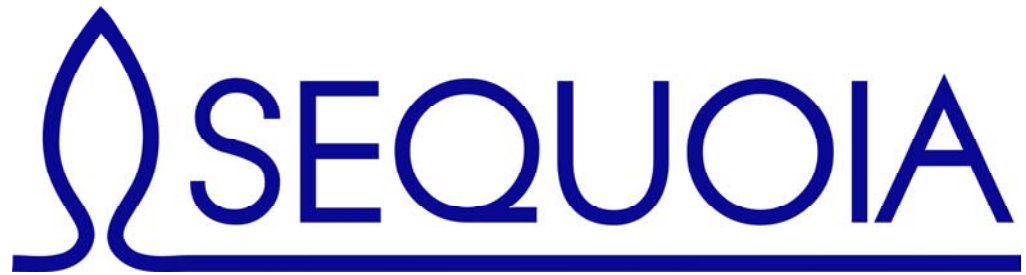

## **FAST TRACER**

### **The USB Triaxial Vibration Analyzer**

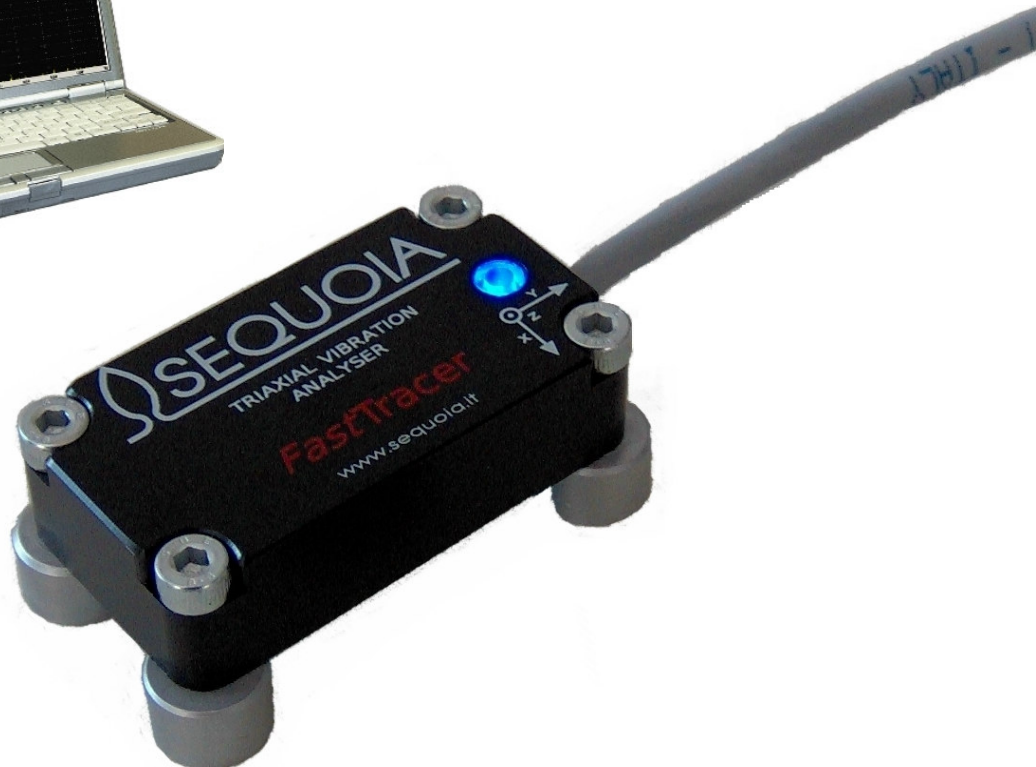
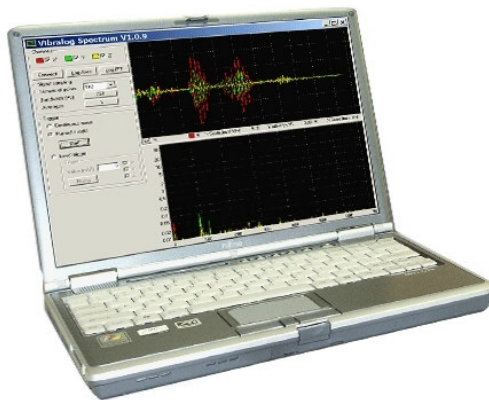

**ROGA-Instruments, Steinkopfweg 7, D-55425 Waldalgesheim**

Tel. +49-6721-984454 Fax +49-6721-984474 [www.roga-instruments.com](http://www.roga-instruments.com)

## **ABSTRACT**

Today's manufacturers business need is to extract maximum profits from the minimum investment in plant and equipment. But how to guarantee the continuous improvement of products and the growth of business? Using suitable instruments for reaching both the aims.

This paper is focused on the importance of vibrations analysis and diagnostic activities for an organization. We are going to speak of Condition Monitoring, or the use of advanced technologies in order to determine equipment condition, and potentially predict failure using vibration measurement and analysis: the Sequoia *FastTRACER* Condition Monitoring scopes.

In maintenance field the term "Condition Monitoring" means a regular and complete check-up of machineries using the vibration level measurement. The competitive advantages of Condition Monitoring could be summarized as follow:

- ❑ replacements and operations are done on the effective machine conditions and not on theoretic planning;
- ❑ no damage due to unforeseen breakage, increase of machine life span;
- ❑ exploitation of the whole working cycle of a machine;
- ❑ reliability in production process and increased productivity;
- ❑ maintenance based on the real machine conditions;
- ❑ planning of stops of machine, decrease wastage;
- ❑ manufacturing line stability;
- ❑ determination of performance issues;
- ❑ machine history reporting and comparative analysis;
- ❑ identification of areas of delay.

So, the use of Condition Monitoring technique is useful for:

- ❑ improving equipment reliability through the effective prediction and avoidance of equipment failures;
- ❑ minimizing downtime through the integrated planning and scheduling of repairs indicated by Condition Monitoring techniques with those indicated by other techniques;
- ❑ maximizing component life by avoiding the conditions that reduce equipment life (for example, by ensuring ongoing precision alignment, minimal lubricant contamination etc.) ;
- ❑ using condition monitoring techniques to maximize equipment performance and throughput;
- ❑ minimizing condition monitoring costs.

The *FastTRACER* allows you to detect specific damage indication and to obtain a defined evaluation on the working condition of the machine. You can use it for specific control, for collecting general data, for real time reading on each of the single axis and measure points.

### ***FASTTRACER GENERAL DESCRIPTION***

The USB Triaxial Acceleration Computer – named *FastTRACER* - is a user friendly, portable and powerful device. It is an instrument sensitive to the accelerations on three axes and it has autonomous signal processing capabilities. With the PC it can be used the powerful vibration analyser which is integrated within the device.

The *FastTRACER* is the developed version of the USB VIBRALOG, the first version of the portable instrument for



*Photograph 1: the FastTRACER dimension*

vibration measurement.

Versatility of our vibration measurement and analysis instrument is a characteristic that allows its use in mechanical field for machinery characterization, predictive maintenance or for improvement quality control.

Among *FastTRACER* qualities there are the capacity to:

- analyze lowest frequency phenomena ( from 0 Hz);
- measure the acceleration, velocity and unbalancing values during the different working processes;
- discriminate, using frequency analysis of signal, different sources of vibration;
- exact data acquisition of dynamic working process;
- record waveforms and the frequency spectrum analysis (FFT) for investigation and historical comparison;
- visualize the natural vibration frequencies which characterise your machines and the waveforms on each axis;
- apply the visualized value as alarm threshold for vibration monitoring purposes.

In fact, vibration measurement is recommended method by ISO normative for general monitoring of machines working condition; in this way it is possible to detect the common damages, as unbalancing, structural weakness, mechanical parts slackening, etc... for obtaining the whole general condition of the machine.

Usually these kind of analysis are made with complex and expensive instruments; our device, using an innovative technology the MEMS accelerometers, has cut the cost without less the and reliability of results.

Being connected to any notebook, the *FastTRACER* allows an excellent visualization and easy storage of the data, by reducing considerably the analysis time compared to traditional vibration measurement systems.

A wide selection of real time analysis features and the triaxial sensor capabilities make it possible to analyse the main vibration phenomena through an easy graphical interface. The *FastTRACER* is able to survive to shock up to 1000g and is rated with the IP67 protection index.

The auto diagnosis function allows constantly assessing proper system operations and measuring reliability, by warning the User of any malfunctioning.

The product development phase has led to the implementation into a single, patented device of the signal acquisition and data processing functions. This has allowed achieving great immunity against electromagnetic disturbances and provides the opportunity of making connections to the PC without signal alteration even at high distances.

## **APPLICATIONS**

The *FastTRACER* is a device for vibration study and analysis in industrial environments, workshops and laboratories. It provides detailed information on the monitored phenomena and allows identifying with precision any defects, their source and severity. The acquired data can be employed for historical comparison and statistical analysis. Moreover, it allows to associate frequency and amplitude values to degenerative phenomena which are potentially harmful for the machinery under analysis.

Application fields include:

- process validation;
- preventive & predictive maintenance;
- quality control;
- test bench;



- industrial service;
- tool wear analysis;
- balancing measurement and evaluation;
- abnormal vibration detection during a working process;
- determination of work piece-tool contact (cut in the air);
- machine stiffness analysis; determination of unwanted clearances in any handling process;
- tables locking verify;
- tool-workpiece contact detection;
- machine-tool stiffness analysis;
- backlash detection.

Companies that implement Condition Monitoring on their equipments expend usually 25% in maintenance less that the companies that don't utilize condition monitoring.

### ***FastTRACER TECHNICAL DESCRIPTION***

The *FastTRACER* is made up of the triaxial sensor and the application software.

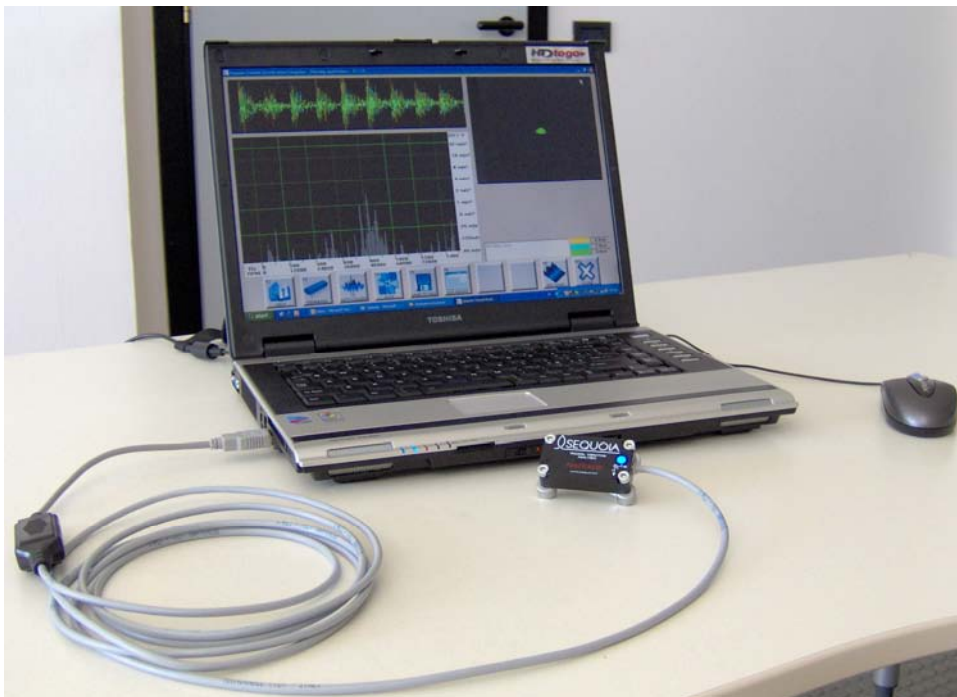

Photograph 2: the *FastTRACER*

The *FastTRACER* includes three MEMS accelerometers, one for each of the Cartesian axis. The accelerometers signals are sampled by a microprocessor integrated within the device.

The PC performs the signal analysis and data communication functions using the *FastTRACER* Application software. Data are plotted on the PC screen for a wide and easy visualization both real time or off-line.

Continuous Autodiagnostic: the *FastTRACER* is able to perform a self test procedure to check the functionality of the system components. If the test fails, an alarm is issued to the user.

### General characteristics

Configuration	Triaxial accelerometer
Full scale	$\pm 5$ g
Communication	USB serial port emulation

### Sensors

Type	MEMS
Dynamic range	89 dB @ 10Hz
Bandwidth	from DC to 1500 Hz
Resolution	1 mg @10Hz
Shock:	Up to 1000 g

### Housing

Weight	55 g
Protection index	IP67
Temperature range	-20° to 70 °C (operating) -40° to 100 °C (non operating)
Humidity	0 to 100 % (non condensing)
Cable	3 m USB cable; till 30 m cable extensions available
Package	Aluminium, 30 x 55.5 x 15 mm

### Software provided

*FastTRACER* application software.  
Vibralog application compatible.

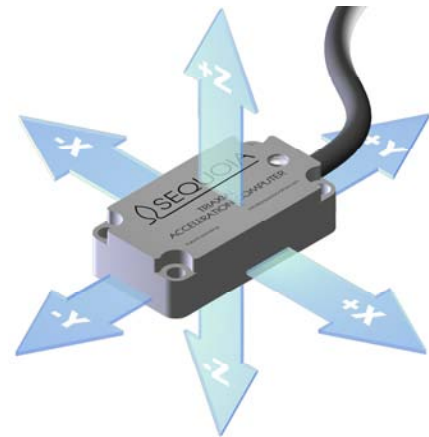

Figure 1: axis orientation

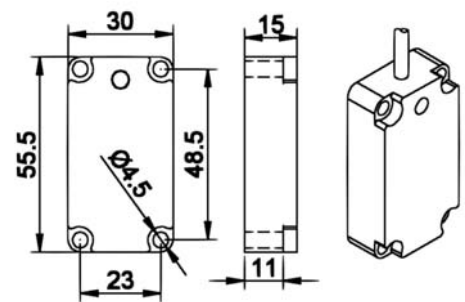

Figure 2: FastTRACER dimensions

## ***FastTRACER INSTALLATION***

Due to the variety of the functions that can be performed by the *FastTRACER*, mounting information cannot be specific for all the equipment and applications. Therefore, the guidelines that follows are only the general instructions that should be considered for mounting the *FastTRACER* and perform correct data acquisitions.

The *FastTRACER* should be mounted in a place where the phenomena to detect can be mechanically transmitted to its box. The closer the sensor is mounted to the source, the more satisfactory the monitoring results will be.

The *FastTRACER* must be secured to the equipment that has to be monitored, using the four magnetic adapter provided with the sensor. If the disturbances to detect are high in frequency, it's recommended to fix the sensor by means of screws.

Much care must be taken to ensure that the fixing devices are securely fastened so that they do not add other vibrations to the monitoring system and do not modify the signal that is measured by the *FastTRACER*.

The sensor must be mounted on the most relevant part of the equipment, i.e. the point in which the measured vibration is effectively representative of the overall stress to which the equipment is subject. For example, when the monitored equipment is a metal cutting machine, the recommended location for fixing the sensor is the machine spindle nose.

## ***FastTRACER SOFTWARE Interface***

Being connected to any notebook, the *FastTRACER* allows an excellent visualization and easy storage of the data, by reducing considerably the analysis time compared to traditional vibration measurement systems. The PC can use the powerful vibration analyser which is integrated within the device, and the device exploits the PC computational capabilities.

The application software of *FastTRACER* can be used to:

- visualise and record the natural vibration frequencies which characterise your machines and the waveforms on each axis;
- visualize a process and monitor the working vibration behavior;
- visualise and record the frequency spectrum analysis (FFT) of each axis for investigation and historical comparison;
- reproduce and analyze the recorded file.

Once the application software is launched, *FastTRACER* is ready to work.

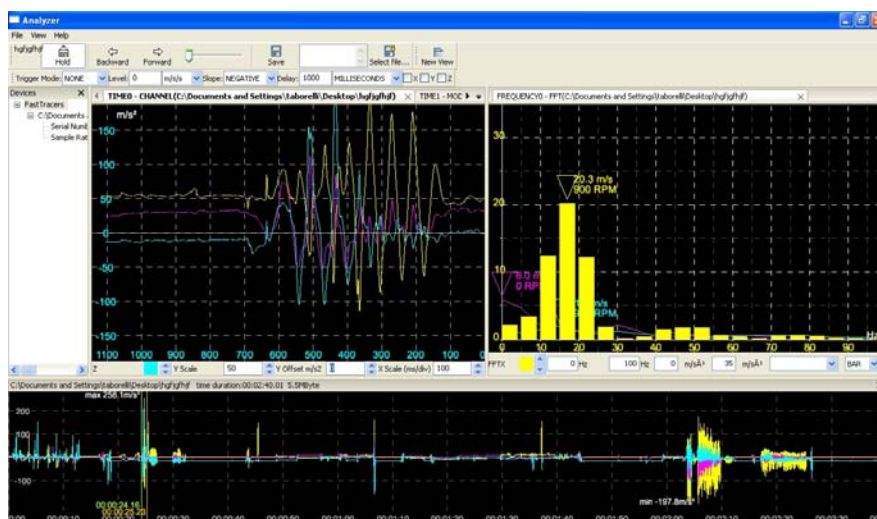

Figure 3: *FastTRACER*-software interface

When the *FastTRACER* application software is started, you have to open a “view on the vibration signal” , and the main window shown in fig. 4 and 5 appears.

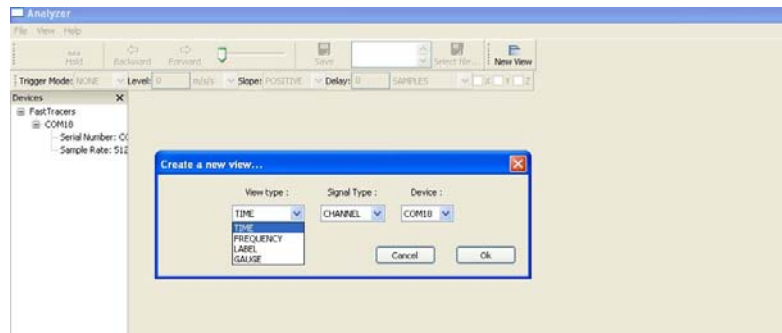

Figure 4: Choice of signal process

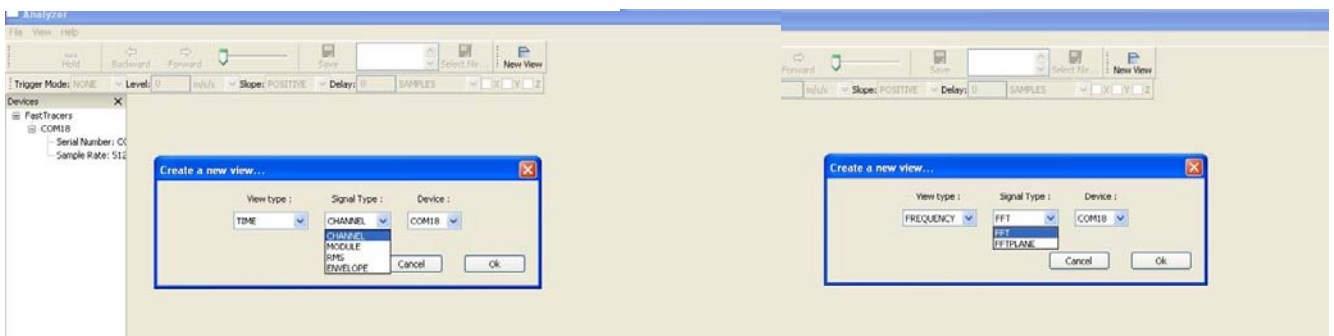

Figure 5: Choice of signal analysis

In these first steps you open a view on the vibration signal, so you have to choose how to process vibration, in time or frequency domain, and in which dimension visualize it, the single axis, the module of acceleration, FFT, ..

Following this creating procedure, the software allows you to open more than one view, for contemporary analysis with different computation algorithms.

When a *FastTRACER* is connected to the USB port of the PC, on the left side of the software window ( identified with “devices”)is shown the number of the port to which the sensor is connected to; it is possible to add more devices to the PC, and visualize contemporary their signals. For making comparison more simple, it is possible as well, to open an other window with a saved signal acquisition. All devices connected to the PC and the files opened are shown in this control window. All the window are configurable, they could be changed in size and position.

The oscilloscope is used for visualizing in real time the signal that is processed by the sensor.



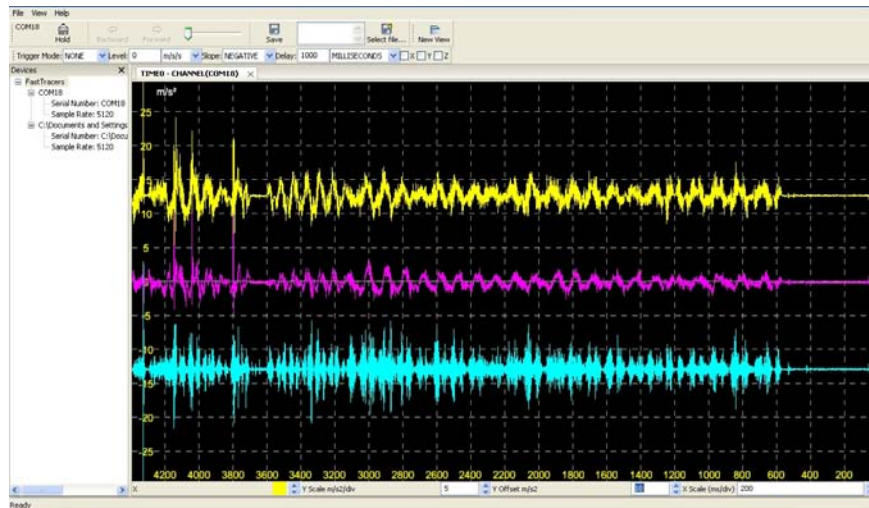

Figure 7: Oscilloscope

The oscilloscope function works like a true oscilloscope. Each track displayed has the following parameters:

- Y Scale: it is the amplitude scale;
- Y Offset: it is the offset of each track;
- X Scale: it is the time scale of the visualisation and is the same for all the tracks.

The oscilloscope is fully configurable with the tools provided at the bottom of the oscilloscope itself (simply use the arrows or tape the values). The user can set for each axis, or for all the axis together, the X Scale, the Y Scale and the Y Offset of each track.

In order to locate isolated events and analyse them, the acquisition process can be triggered by setting a signal threshold. This choice is made in the “Trigger mode” frame by selecting between different trigger option; the tools allows user to set acquisition parameters: the trigger level, the curve slope, the axis to analyse, the delay of acquisition i.e. how many samples or seconds will be acquired after the trigger event,...

In the frequency domain analysis it is computed the FFT of the signal, on each of the three axis (figure 8). Using the arrows, it is possible to choose which of the three axis putting in emphasis, in fact the software plots the three axis FFT.

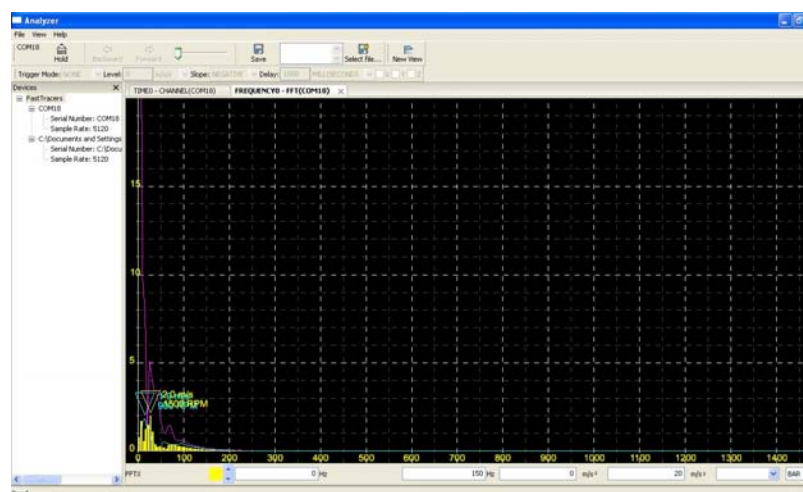

Figure 8: FFT analyzer

The spectrum is configurable with the tools provided at the bottom of the window. It could be set the bandwidth range, the Y Scale, the FFT resolution, the visualization (bars or lines), the linear or algorithmic computation. Automatically, it is always showed the pick value of the FFT for each axis.

For data analysis, using the tools “Hold” and “Backward” and “Forward” the user could stop the acquisition, going backward and forward commands to scroll through the signal, both in real time both in off line analysis.

To save the acquisition there are the keys “Select file” and “Save”, a window appears for choosing file destination. The closed window shows the directory in which the file has been saved and the file name.

To open saved file click on the left side of “devices” window or select “New file device” (figure 6).

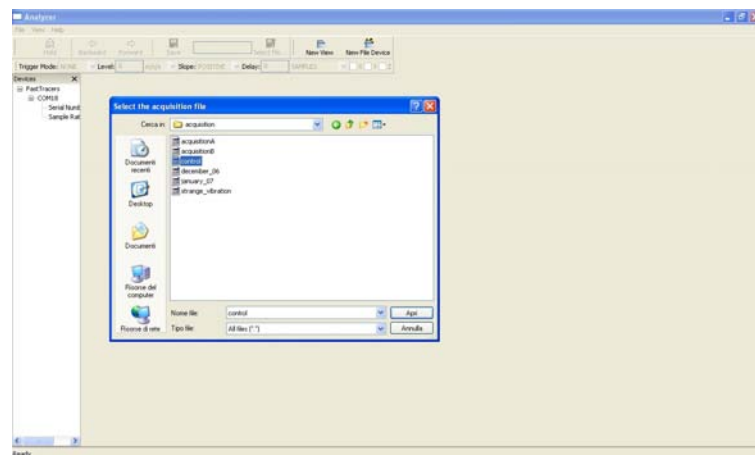

Figure 6: open a new file

Selecting the file saved before, the software plots, on the bottom of the window, the whole signal in time domain. Using the “new view” tool, the user opens new windows in the suitable signal visualization for the analysis, in time or frequency domain.

In the signal reproducing window are visualized two cursors: the green one can be moved through the acquisition to define the star point of reproduction of the signal or for associating to a phenomena visualized its corresponding moment respecting to the beginning of recording. The yellow cursor scrolls through the signal during its reproduction (figure 7). In this window is visualized the maximum and the minimum of signal value.

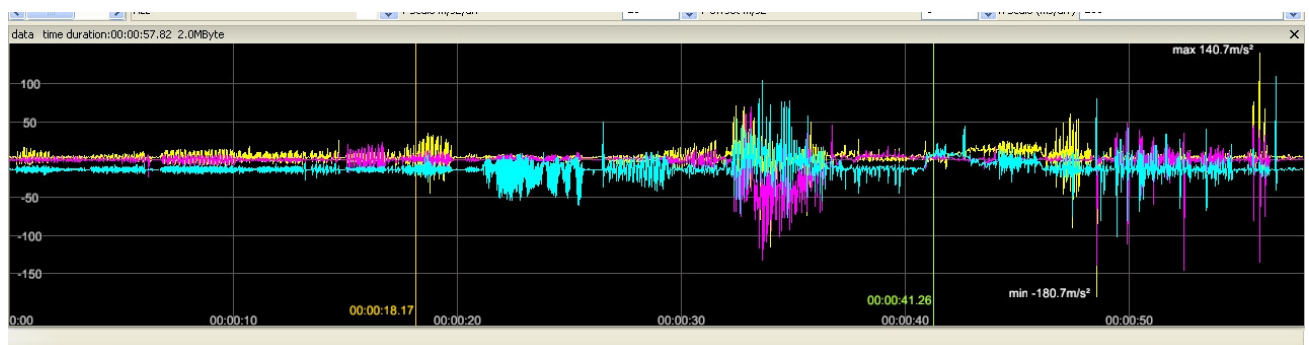

Figure 7: the reproducing window

During the file reproduction the user can use the tool for real time analysis: to scroll along the time, stop the acquisition, download the data about the visualized signal, change the visualization parameters, etc...

The software characteristic is the high configurability: it is possible to connect many devices, making real time comparison with historic acquisition, stop of the signal acquisition for a rapid evaluation and to start again the acquisition without having lost any information.

In order to use the Vibralog Application software with the *Fast Tracer* device you must use the software Vibralog Application 1.8 (this application is able to work both with Vibralog and *Fast Tracer*).

## CASE HISTORY:

### Control of parasitic dynamics on a robot

In collaboration with an important Italian Robot Company, it has been realized a test on the applicabilities of the Sequoia device in that application field.

Particularly, tests aim was the detection and measurement of eventual parasitic dynamic forces (on Y and Z axis) during the linear inversion on X axis.

The sensor was applied on the robot axis and immediately it had acquired the movement signal and plotted a clear behaviour.

Analysing the acceleration signal, it was possible to see that the two axis, not involved in the movement, were in the reality strongly stressed.

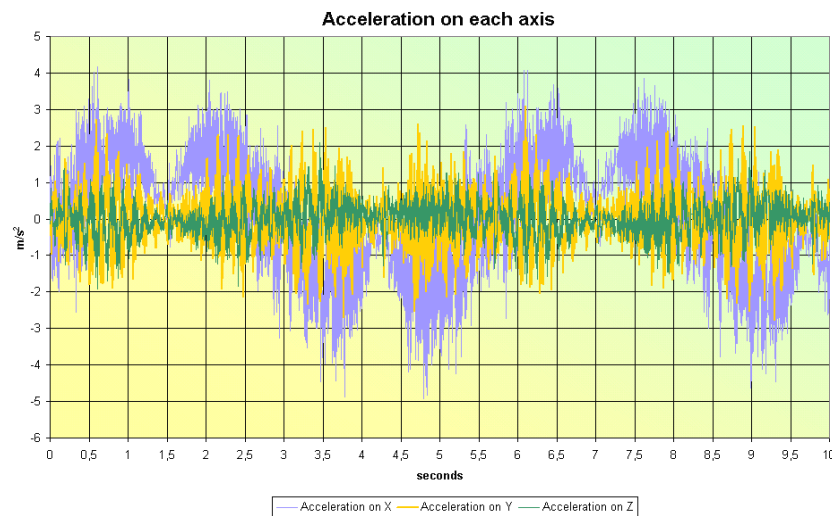

The software *FastTracer* Application is able to download the numeric value pure acceleration data; acceleration data were integrated for obtaining the value in velocity and displacement. Using this computed values it was possible to develop specific conclusions.

From the comparison between acceleration and velocity signal there were found the inversion points of the X axis; around these points were analyzed the other axis behaviour to verify the design parameters to be respected. In fact *FastTRACER* is suitable to be use to verify designed or construction parameters , control the affect of a change on a structure part as well as for the quality control on a finished product.

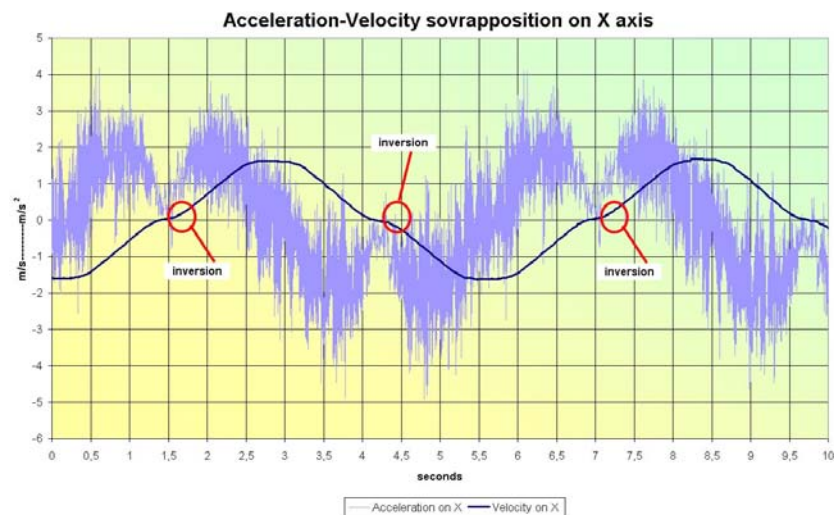

The analysis has been made during the signal acquisition and at the end of the test, had showed the real strains which the Y and Z were subjected to, during the cyclic linear inversion on X axis.

It was noticed that, above all on vertical axis (the Y axis of the sensor for mounting reasons) the parasitic dynamic forces were not at all negligible .

